

ZASTOSOWANIE

Urządzenia boczno-kanałowe mają zastosowanie w transporcie pneumatycznym. Typowe zastosowania:

- transport pneumatyczny, poczta pneumatyczna,
- maszyny graficzne, podnośniki pneumatyczne, wielostopniowe urządzenia filtracyjne o bardzo wysokim stopniu separacji pyłów,
- odkurzacze przemysłowe, napowietrzanie basenów w biologicznych oczyszczalniach ścieków, galwanizerniach, etc.,
- do bezolejowego transportu, nieagresywnych i niewybuchowych gazów.

KONSTRUKCJA

- wentylator boczno-kanałowy o napędzie bezpośrednim,
- wirnik odlewany ze stopu aluminium, wyważony dynamicznie wg ISO 1940-1,
- obudowa odlewana ze stopu aluminium,
- wentylator przystosowany do pracy w pozycji poziomej lub pionowej,
- wentylator malowany na kolor szary RAL 7042,
- maksymalna temperatura tłoczonego medium 60°C,
- temperatura otoczenia silnika od -20°C do +40°C.

SILNIK ELEKTRYCZNY

- asynchroniczny, jednofazowy, 230 V, 50 Hz (do mocy 2,2 kW),
- asynchroniczny, trójfazowy, 230/400 V, 50 Hz (o mocy do 3 kW),
- asynchroniczny, trójfazowy, 400/690 V, 50 Hz (o mocy od 4 kW),
- klasa sprawności IE3 (od mocy 0,75 kW) lub IE2 (poniżej mocy 0,75 kW),
- stopień ochrony IP55,
- klasa izolacji F,
- do regulacji częstotliwościowej (silniki trójfazowe),
- zabezpieczenie termiczne (TP lub TP i PTC) - w wybranych silnikach,

Schemat podłączenia elektrycznego: rys. 7, 8

WYKONANIA SPECJALNE

- silnik na inne niż standardowe napięcie oraz częstotliwość zasilania,
- silnik jednofazowy przystosowany do regulacji napięciowej,
- silnik o innym stopniu ochrony IP,
- silnik wyposażony w czujniki lub dodatkowe chłodzenie,
- uszczelnienie między obudową a silnikiem (simmering),
- maksymalna temperatura tłoczonego medium powyżej 60°C,
- temperatura otoczenia silnika poniżej -20°C oraz powyżej +40°C,
- napęd pasowy.

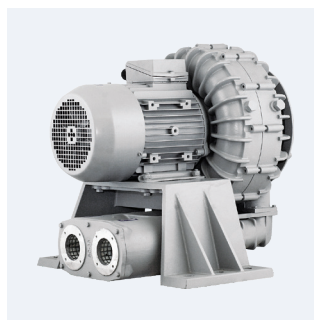

Wersja dwustopniowa
DSC/PSC

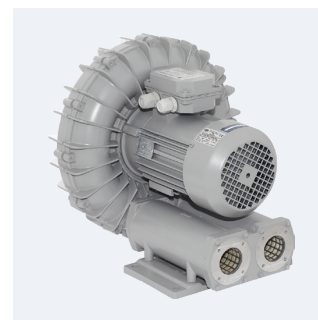

Wersja z silnikiem 100Hz
SC-F



Wersja z napędem pasowym
SC-VB

DANE TECHNICZNE

Typ	wydajność max	ciśnienie max ssanie i tłoczenie		prędkość obrotowa	napięcie	natężenie	moc silnika	kondensator	poziom ciśn. akust.*	masa	nr artykułu
	[m³/h]	[mbar]		[obr/min]	[V]	[A]	[kW]	[µF]	[dB(A)]	[kg]	
TRÓJFAZOWE											
SC10A 037T	110	126	125	2800	230Δ/400Y	1,75/1	0,37	-	71	15	46511010
SC10A 055T	110	175	185	2790	230Δ/400Y	2,35/1,35	0,55	-	72	16	46511030
SC10C 075T	110	225	270	2890	230Δ/400Y	2,95/1,7	0,75	-	73	18,5	436511050
SC20A 110T	190	202	200	2890	230Δ/400Y	4,3/2,5	1,1	-	75	22	436511070
SC20A 150T	190	202	275	2880	230Δ/400Y	5,25/3,0	1,5	-	75	24,5	436511100
SC20C 110T	190	200	200	2890	230Δ/400Y	4,3/2,5	1,1	-	77	22	436511090
SC20C 150T	190	270	275	2880	230Δ/400Y	5,25/3,0	1,5	-	75	24,5	436511110
SC30A 220T	320	250	250	2895	230Δ/400Y	7,9/4,6	2,2	-	77	36	436511130
SC30A 300T	320	250	300	2870	230Δ/400Y	11,0/6,3	3	-	78	40	436511155
SC30C 220T	320	250	250	2895	230Δ/400Y	7,9/4,6	2,2	-	80	36	436511160
SC30C 300T	320	300	300	2870	230Δ/400Y	11,0/6,3	3	-	78	40	436511170
SC40A 400T	650	210	220	2895	400Δ/690Y	7,3/4,2	4	-	81	67	436511180
SC40A 550T	650	300	300	2890	400Δ/690Y	9,8/5,7	5,5	-	82	70	436511190
SC40A 750T	650	300	395	2885	400Δ/690Y	14,0/8,1	7,5	-	84	73	436511200
SC40C 550T	650	300	300	2890	400Δ/690Y	9,8/5,7	5,5	-	84	70	436511220
SC40C 750T	650	350	395	2885	400Δ/690Y	14,0/8,1	7,5	-	86	73	436511230
SC46A 750T	750	200	200	2885	400Δ/690Y	14,0/8,1	7,5	-	82	105	436511240
SC46A 1100T	750	350	420	2900	400Δ/690Y	19,1/11,1	11	-	84	120	436511242
SC46C 750T	800	200	200	2885	400Δ/690Y	14,0/8,1	7,5	-	84	105	436511244
SC46C 1100T	800	360	420	2900	400Δ/690Y	19,1/11,1	11	-	86	120	436511246
SC50A 750T	1100	175	175	2885	400Δ/690Y	14,0/8,1	7,5	-	82	126	436511250
SC50A 1100T	1100	325	320	2900	400Δ/690Y	19,1/11,1	11	-	84	128	436511260
SC50A 1500T	1100	360	420	2940	400Δ/690Y	26,6/15,4	15	-	88	155	436511270
SC50C 750T	1100	180	175	2885	400Δ/690Y	14,0/8,1	7,5	-	84	126	436511280
SC50C 1100T	1100	325	325	2900	400Δ/690Y	19,1/11,1	11	-	86	128	436511290
SC50C 1500T	1100	375	420	2940	400Δ/690Y	26,6/15,4	15	-	88	155	436511300
JEDNOFAZOWE											
SC10A 037S	110	126	125	2760	230	3	0,37	12	70	18	46511020
SC10A 055S	110	175	185	2780	230	3,6	0,55	20	72	19	46511040
SC10C 075S	110	225	270	2800	230	5	0,75	25	73	21,5	46511060
SC20A 110S	190	202	200	2800	230	7,2	1,1	30	75	25	46511080
SC20A 150S	190	202	275	2740	230	9,1	1,5	40	77	26	46511115
SC20C 110S	190	200	200	2800	230	7,2	1,1	30	75	25	46511095
SC20C 150S	190	270	275	2740	230	9,1	1,5	40	77	26	46511120
SC30A 220S	320	250	250	2800	230	14	2,2	b/d	78	43	46511135

* z tłumikiem

CHARAKTERYSTYKI PRACY

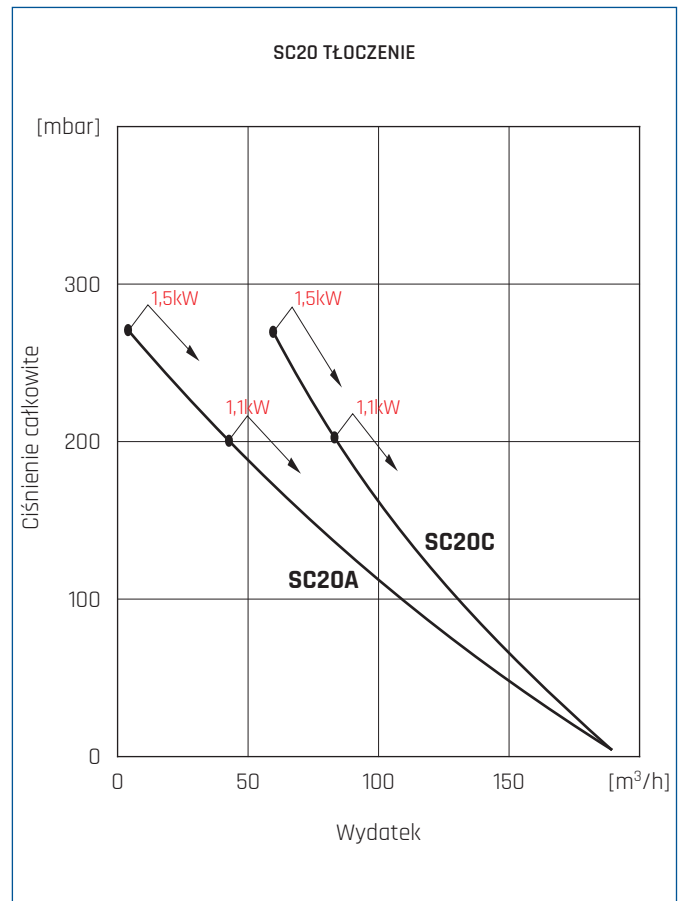
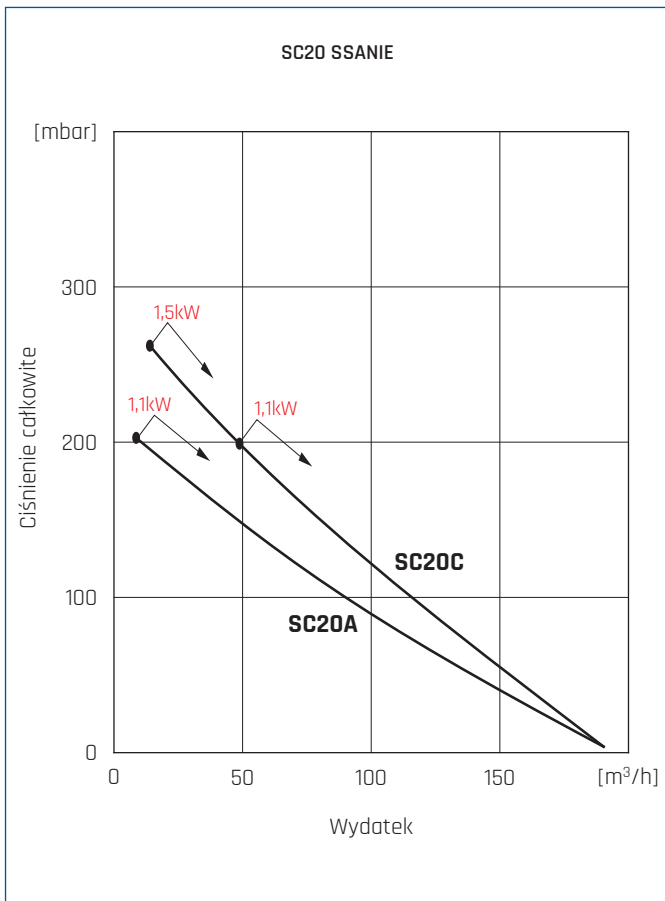
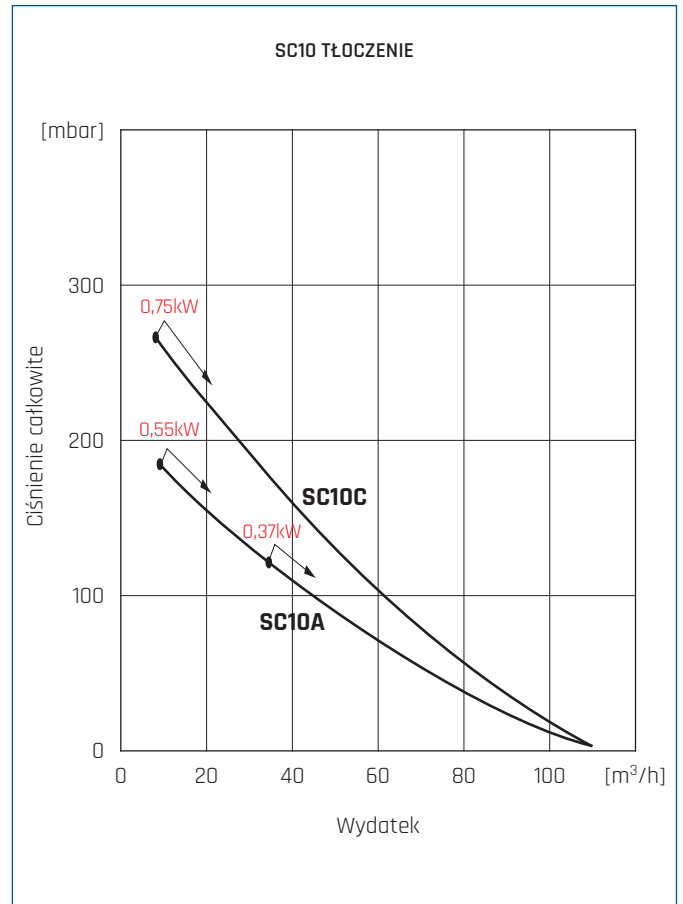
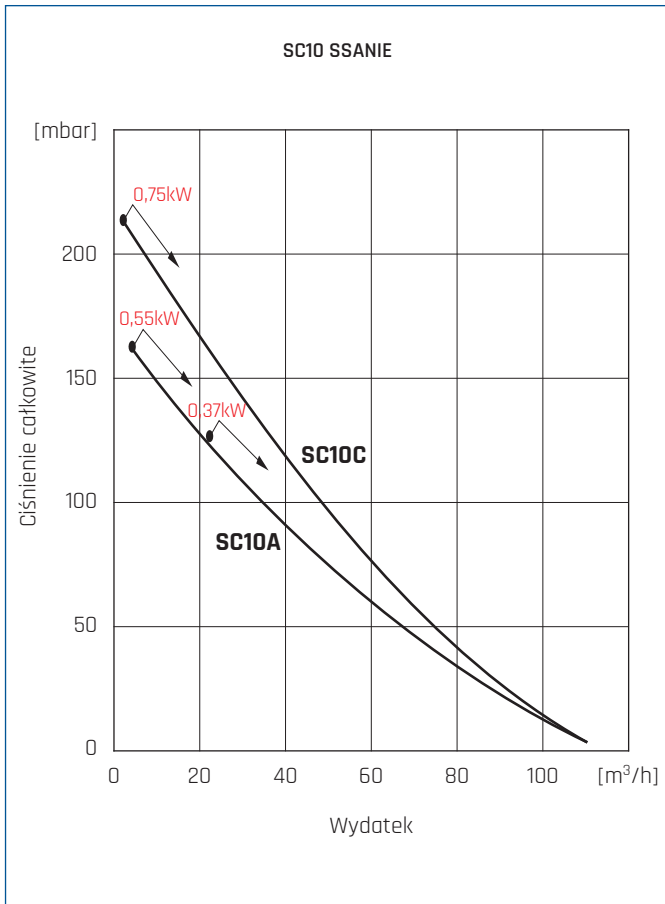

CHARAKTERYSTYKI PRACY

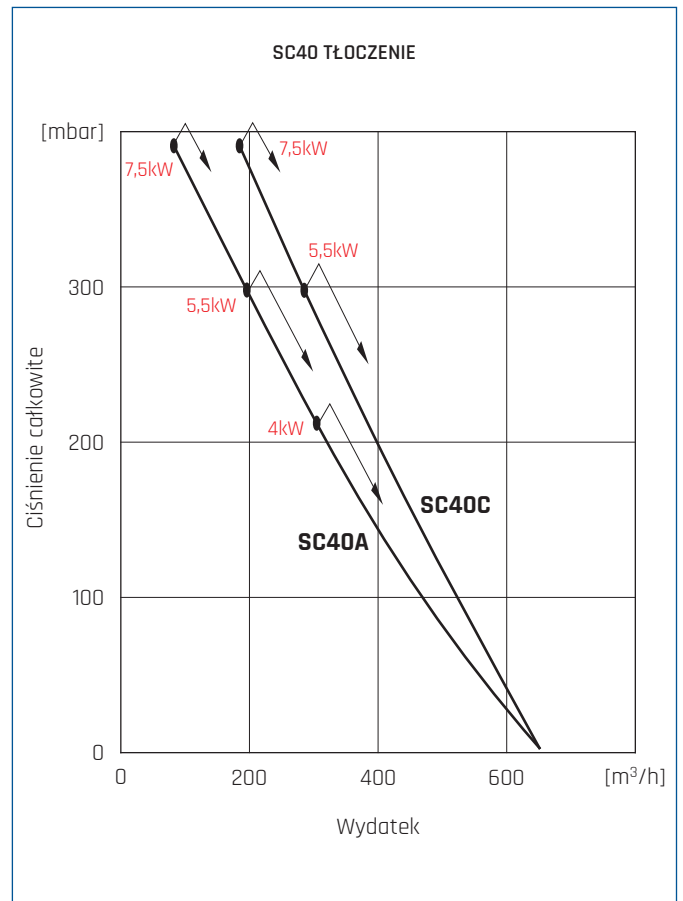
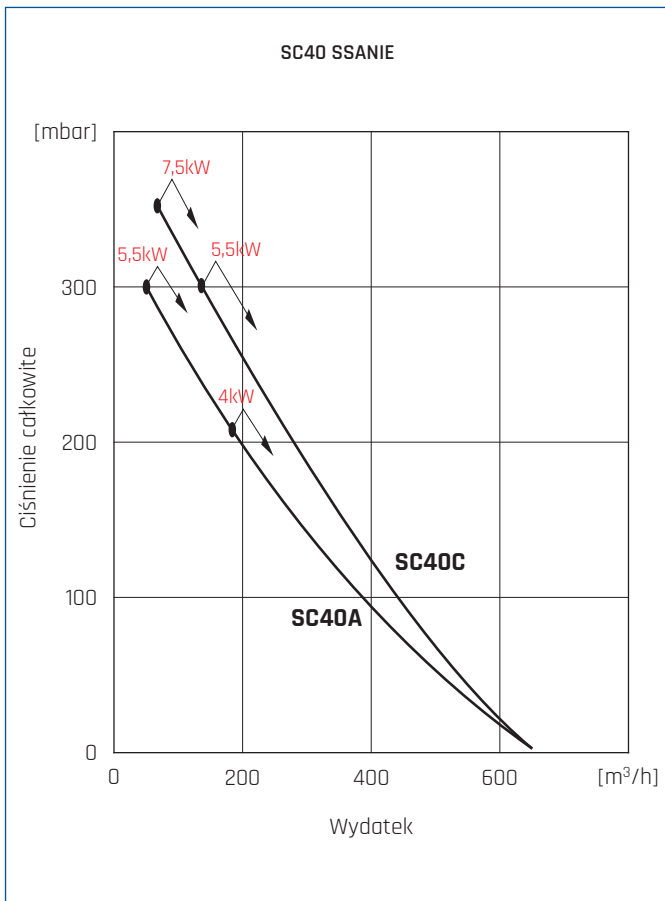
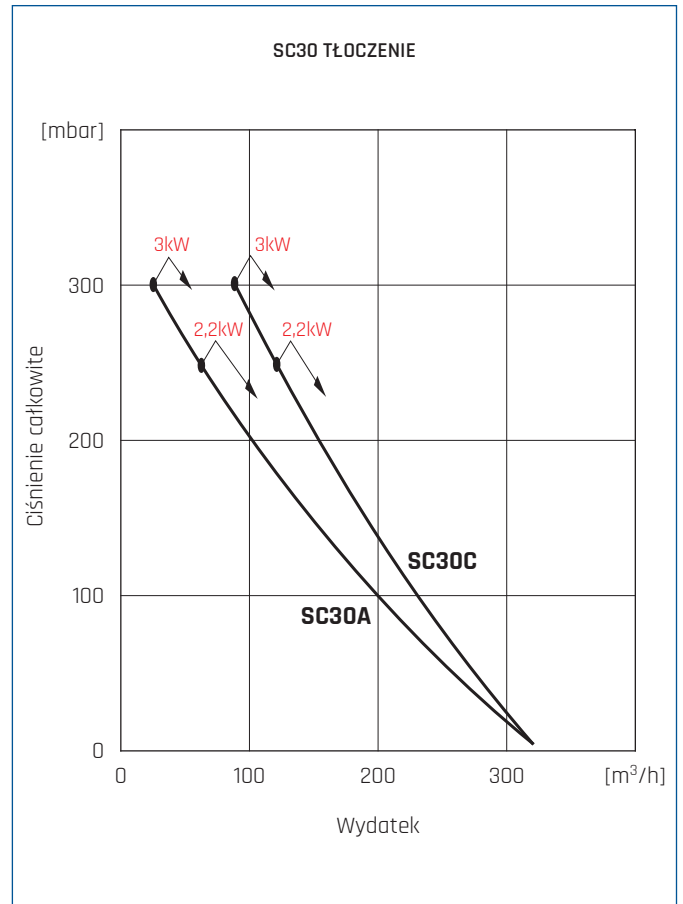
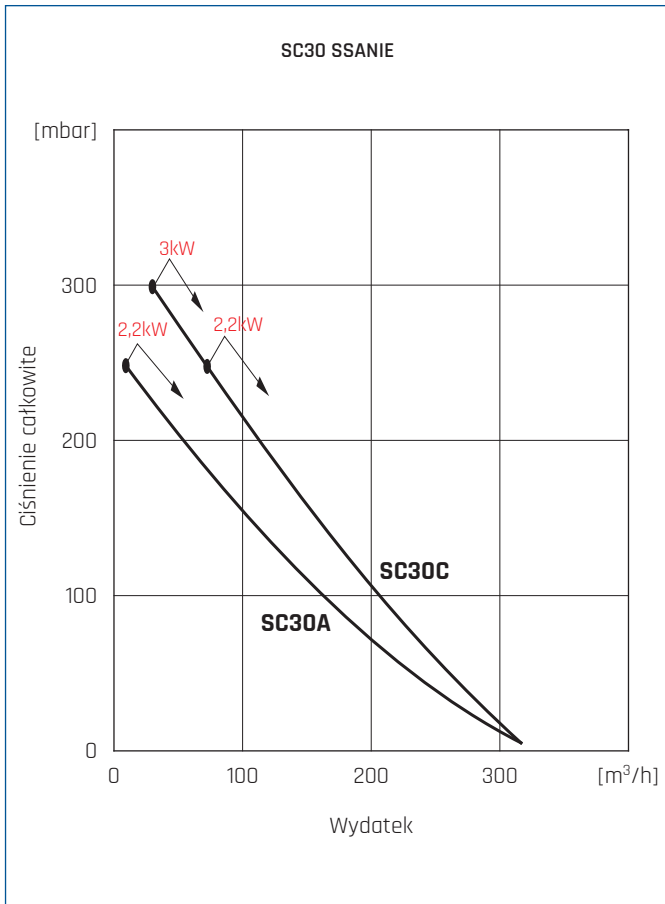

CHARAKTERYSTYKI PRACY

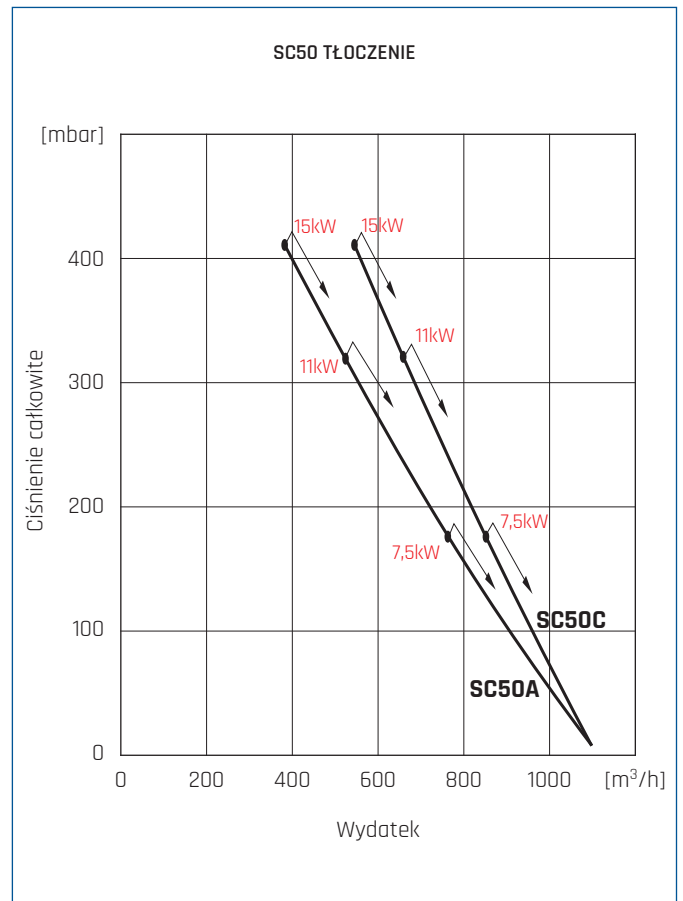
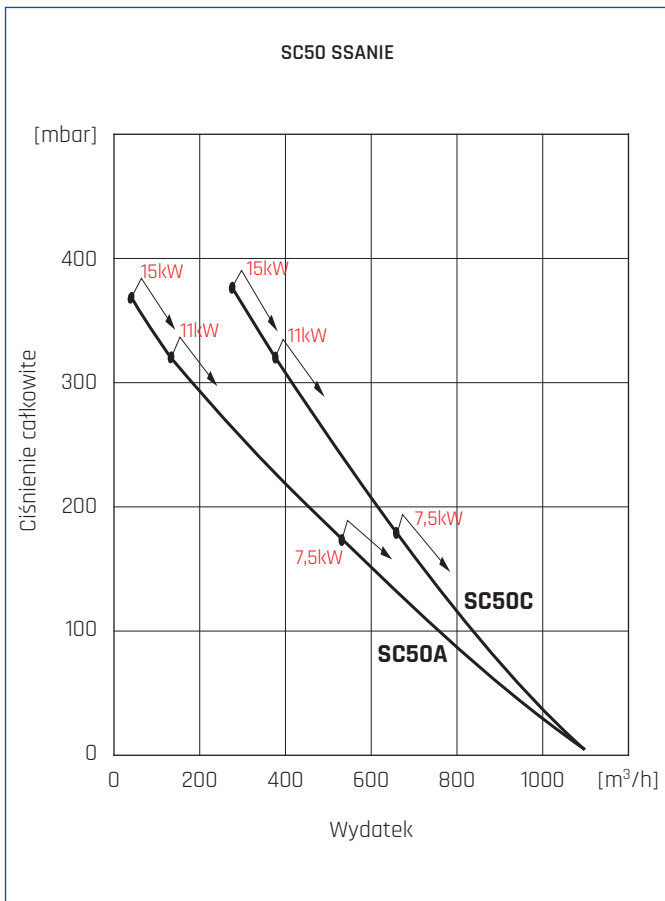
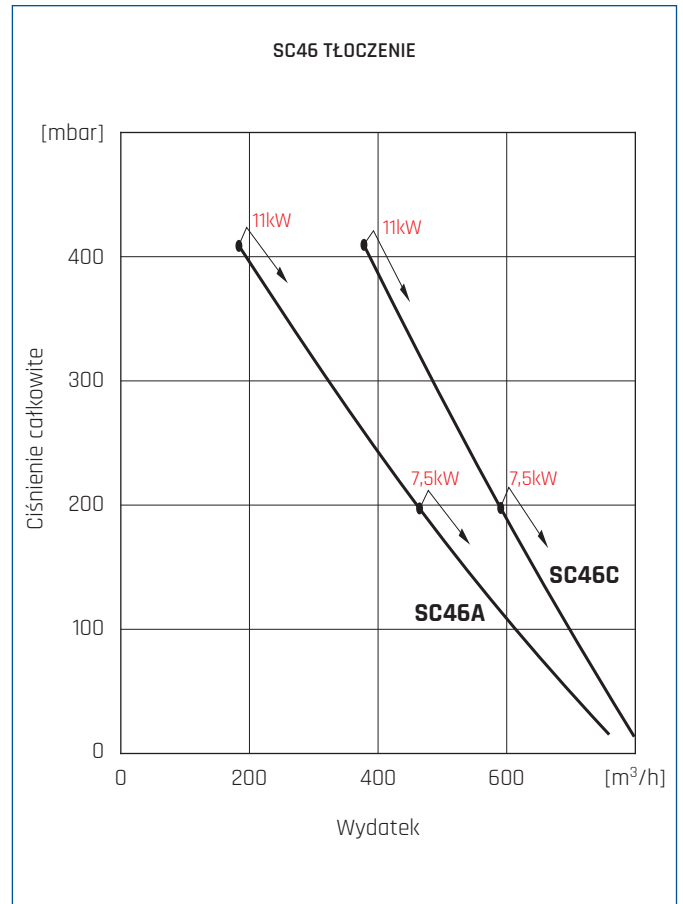
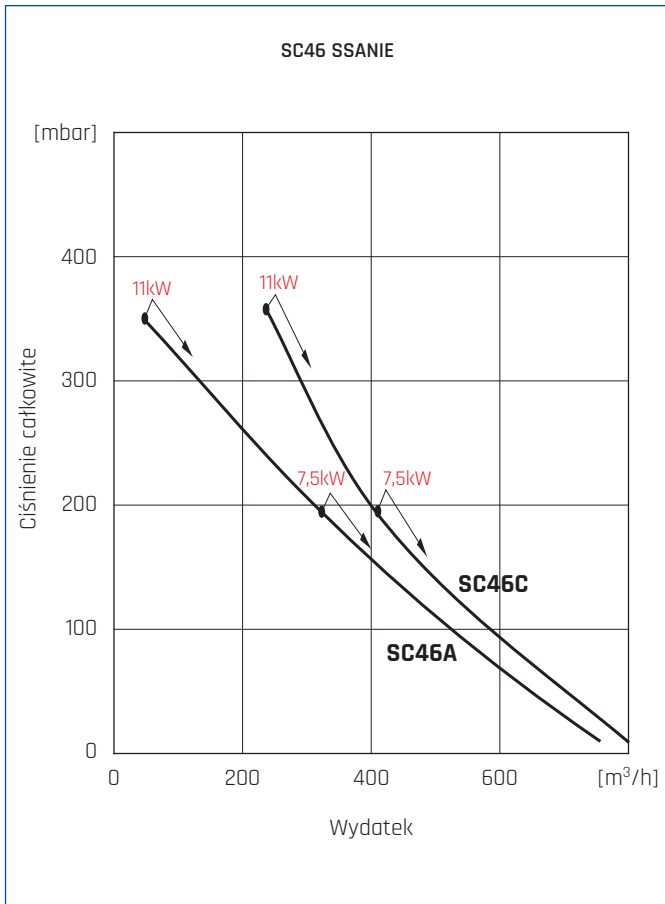

WYMIARY [mm]

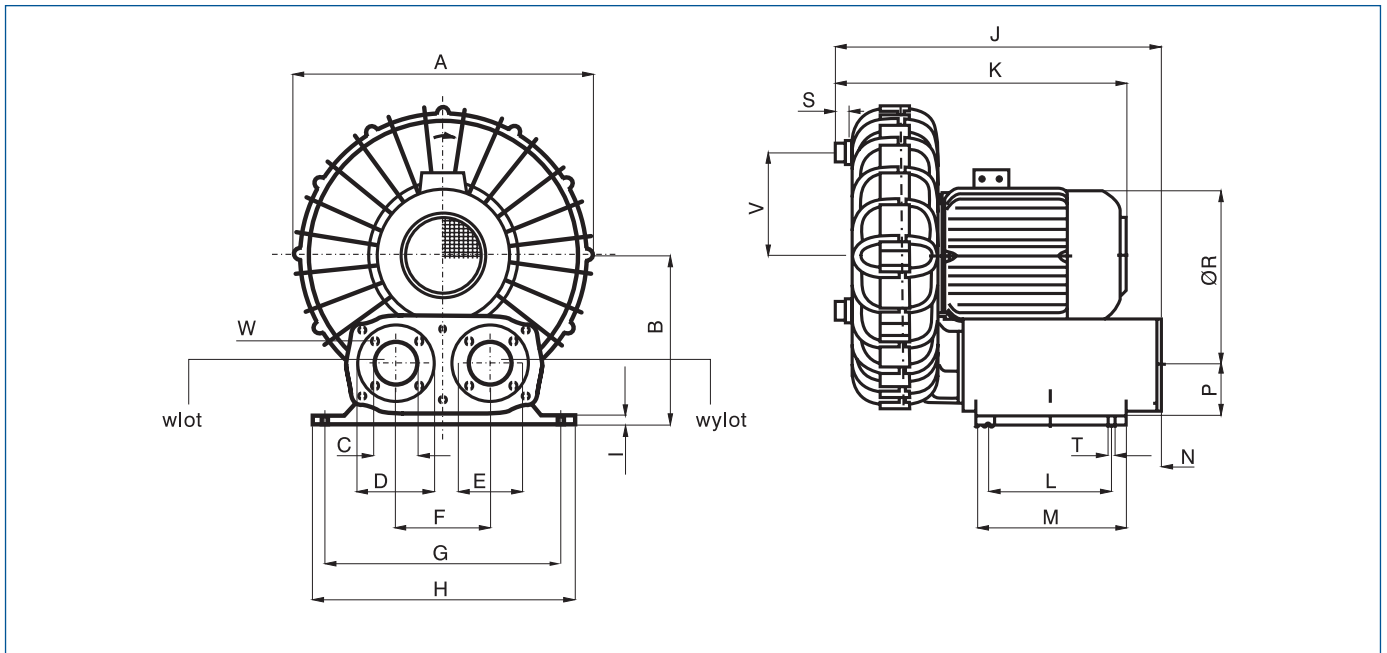

Typ	A	B	C	D	E	F	G	H	I	J	K	L	M	N	P	ØR	S	T	W	V
SC10	296	170	45	80	68	90	220	250	12	340	311	120	150	66	60	141	15	11	M5	117
SC20	360	200	45	80	68	90	220	250	12	370	390	120	150	66	60	157	15	11	M5	129,5
SC30	395	225	55	100	85	125	310	350	12	425	410	160	200	72	80	175	20	13	M6	140
SC40	480	275	75	130	110	145	365	420	12	535	520	260	300	34	80	230	30	14	M8	172
SC46	540	303	100	150	130	160	400	450	20	660	600	370	430	50	-	-	30	20	M8	-
SC50	580	336	100	150	130	160	400	450	25	685	650	370	430	50	95	258	30	20	M8	202

AKCESORIA MONTAŻOWE

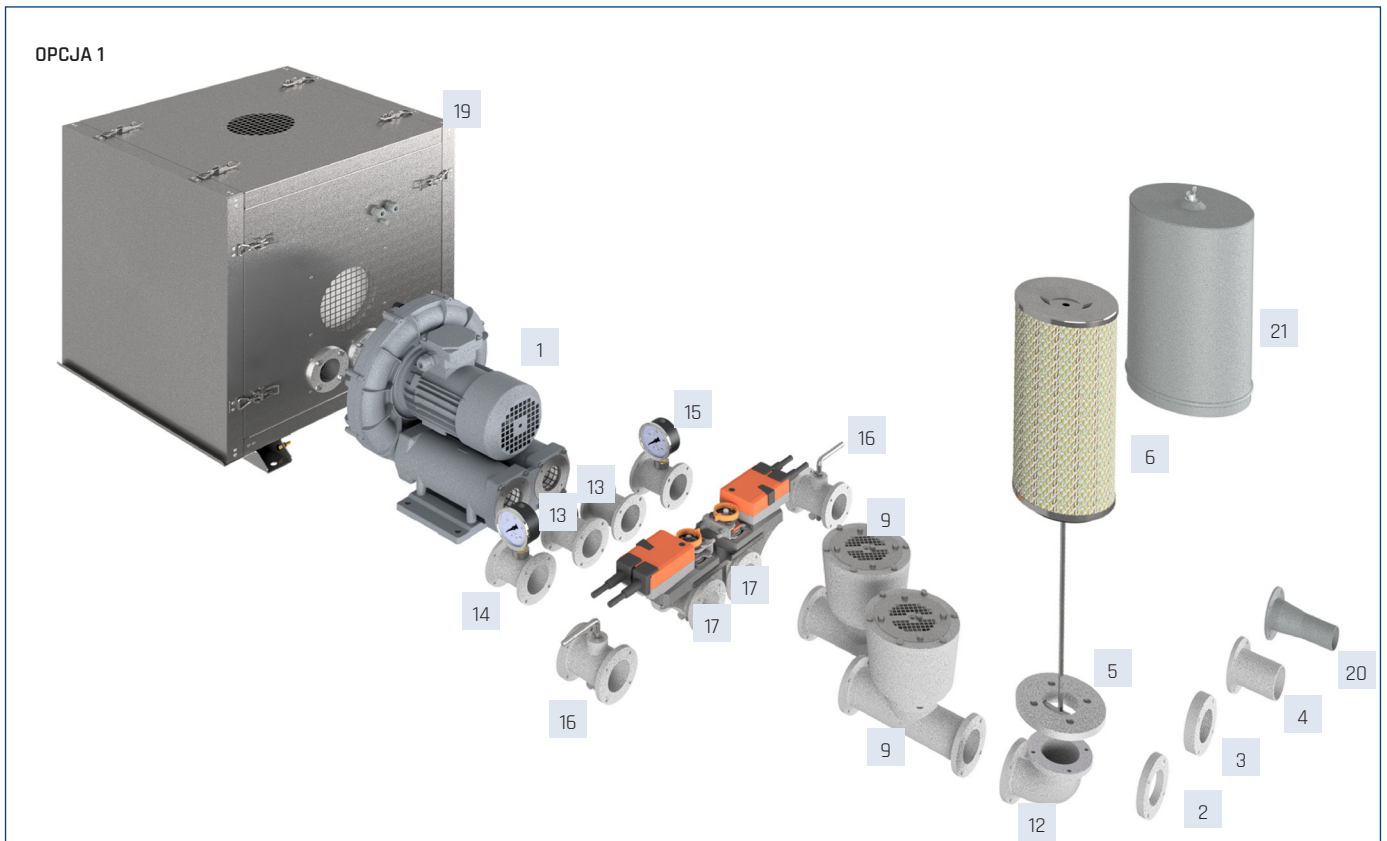

AKCESORIA MONTAŻOWE

OPCJA 2

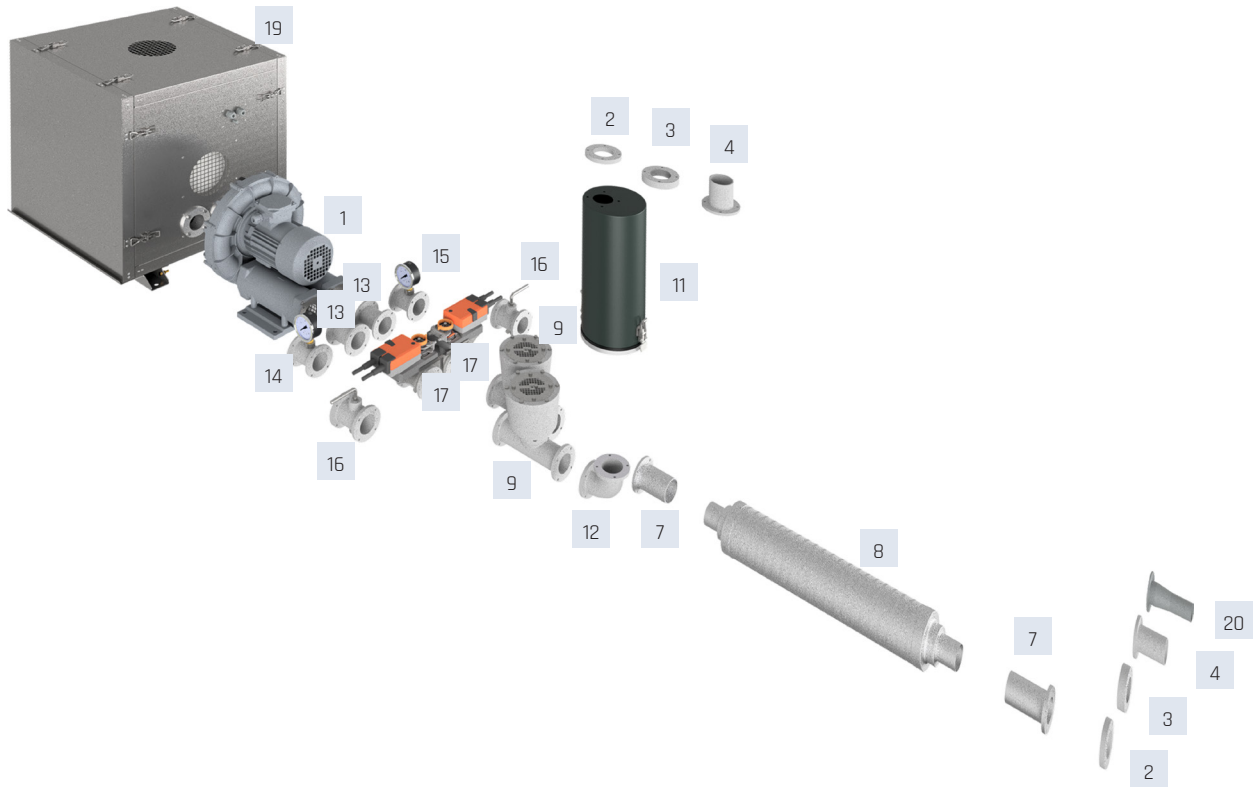

OPCJA 3

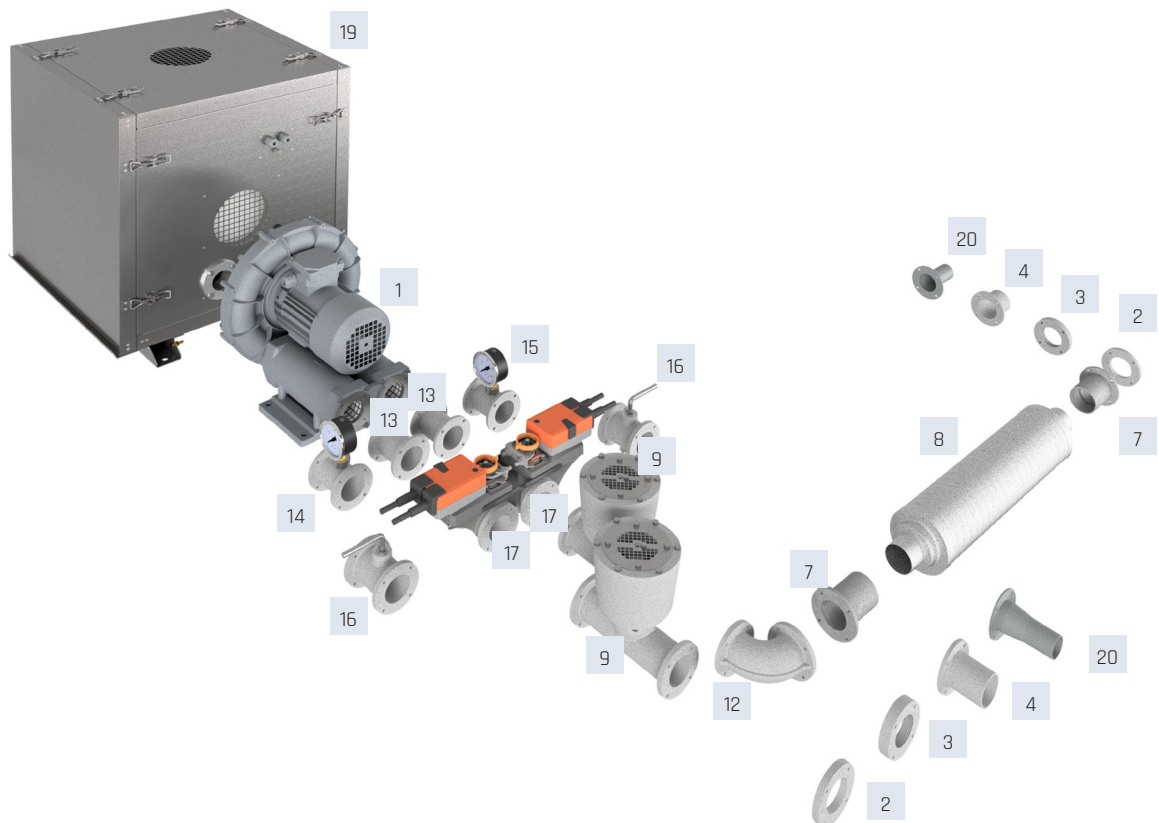

AKCESORIA MONTAŻOWE

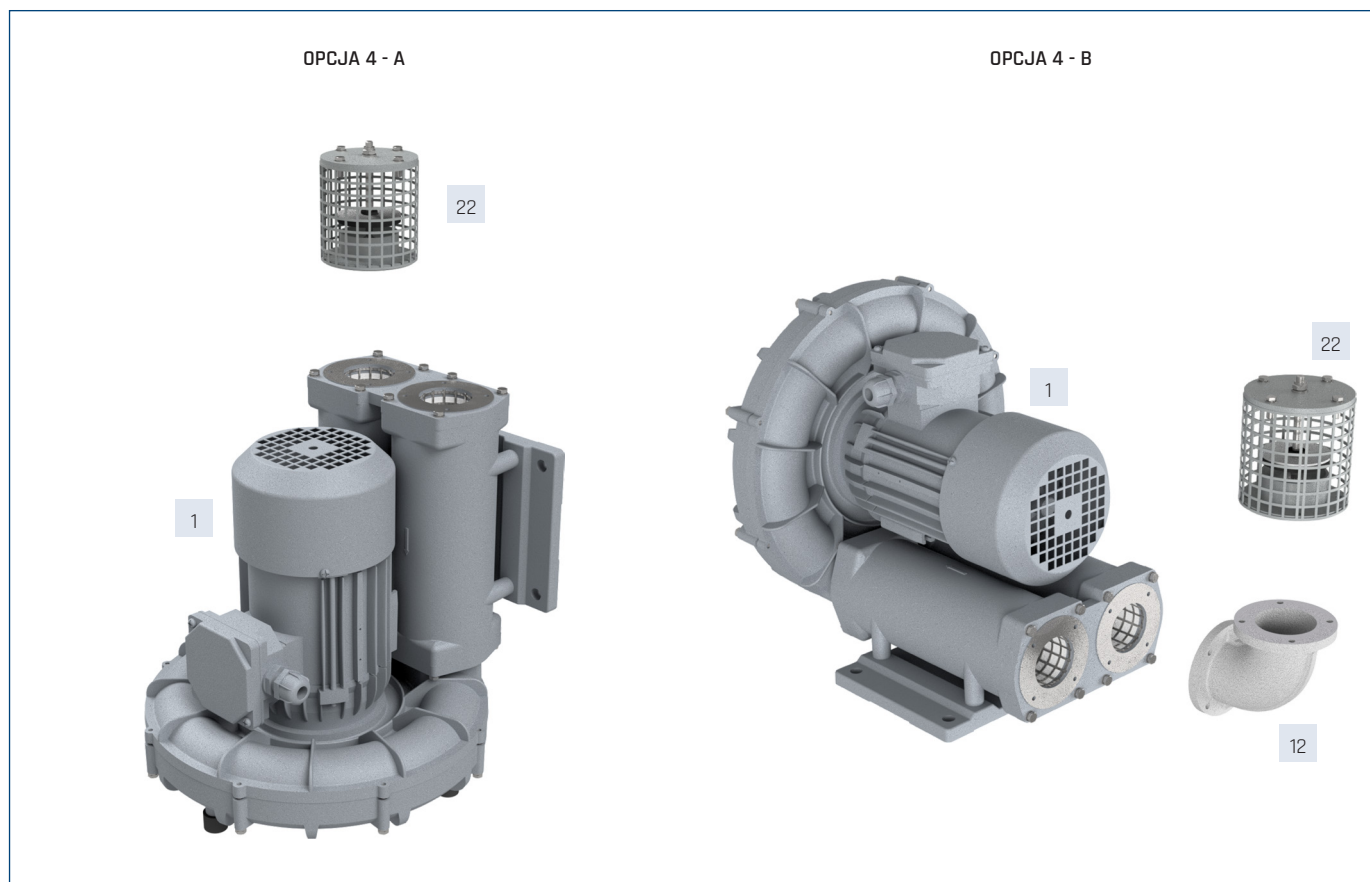











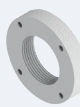

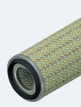

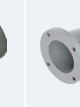

AKCESORIA MONTAŻOWE

1	2	3	4	5	6	7	8	9	
Wentylator	kołnierz do spawania	kołnierz gwintowany	króciec ssawny	króciec do filtra	filtr	króciec przyłączeniowy	tłumik	zawór przeciętny TŁOCZENIE	zawór przeciętny SSANIE
SC10	45516500	45516600	46515210	46515110	46515039	46515250	46525310	46515520	46515522
SC20	45516500	45516600	46515210	46515110	46515039	46515250	46525310	46515524	46515526
PSC30	45516510	45516610	46515220	46515120	46515039	46515260	46525320	46515530	46515530
SC30	45516510	45516610	46515220	46515120	46515039	46515260	46525320	46515530	46515532
DSC30	45516510	45516610	46515220	46515120	46515039	46515260	46525320	46515534	46515546
PSC40	45516520	45516620	46515230	46515130	46515038	46515270	46525330	46515540	46515540
SC40	45516520	45516620	46515230	46515130	46515038	46515270	46525330	46515540	46515542
DSC40	45516520	45516620	46515230	46515130	46515038	46515270	46525330	46515544	46515546
SC46/SC50	45516530	45516630	46515240	46515140	46515038	46515280	46525340	46515550	46515552

AKCESORIA MONTAŻOWE

1	11	12	13	14	15	16	17	18	19	20
Wentylator	filtr kanałowy	kolano	króciec dwukołnierzowy	manometr nadciśnieniowy	manometr podciśnieniowy	przepustnica ręczna	przepustnica automatyczna	uszczelka EPDM	obudowa dźwiękochłonna	redukcja
SC10	46515070	25515285	46515160	46515460	46515461	46515162	46515163	91020025-10	70510321	46515290 D=100mm
SC20	46515070	25515285	46515160	46515460	46515461	46515162	46515163	91020025-10	70510321	46515290 D=100mm
SC/DSC/PSC30	46515075	25515286	46515170	46515470	46515471	46515172	46515173	91020025-11	70510322	46515291 D=130mm
SC/DSC/PSC40	46515080	25515287	46515180	46515480	46515481	46515182	46515183	91020025-12	70510323	46515292-01 D=60mm 46515292 D=150mm
SC46/SC50	46515085	25515288	46515190	46515490	46515491	46515192	46515193	91020025-13	70510324	46515293-01 D=60mm

1	21	22	23
Wentylator	filtr powietrza z osłoną	kołnierz z zaworem	filtr kanałowy ze wskaźnikiem zabrudzenia
SC10	46515151	46515511	46515071
SC20	46515151	46515511	46515071
SC/DSC/PSC30	46515152	46515512	46515076
SC/DSC/PSC40	46515153	46515513	46515081
SC46/SC50	46515154	46515514	46515086

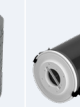
									
kołnierz do spawania	kołnierz gwintowany	króciec ssawny	króciec do filtra	filtr	króciec przytłaczający	tłumik	zawór przeciążeniowy	filtr kanałowy	kolano
									
króciec dwukołnierzowy	manometr nadciśnieniowy	manometr podciśnieniowy	przepustnica ręczna	przepustnica automatyczna	obudowa dźwiękochłonna	redukcja	filtr powietrza z osłoną	kołnierz z zaworem	filtr kan. ze wskaźnikiem zabrudzenia

AKCESORIA ELEKTRYCZNE

Wentylator	falownik	rozłącznik serwisowy
SC10A 037T	L 0.4kW	R-S 3-F + SP, 10A
SC10A 055T	L 0.75kW	R-S 3-F + SP, 10A
SC10C 075T	L 0.75kW	R-S 3-F + SP, 10A
SC20A 110T	L 1.5kW	R-S 3-F + SP, 10A
SC20A 150T	L 1.5kW	R-S 3-F + SP, 10A
SC20C 110T	L 1.5kW	R-S 3-F + SP, 10A
SC20C 150T	L 1.5kW	R-S 3-F + SP, 10A
SC30A 220T	L 2.2kW	R-S 3-F + SP, 10A
SC30A 300T	L 4.0kW	R-S 3-F + SP, 10A
SC30C 220T	L 2.2kW	R-S 3-F + SP, 10A
SC30C 300T	L 4.0kW	R-S 3-F + SP, 10A
SC40A 400T	L 4.0kW	R-S 3-F + SP, 10A
SC40A 550T	L 5.5kW	R-S 3-F + SP, 10A
SC40A 750T	L 7.5kW	R-S 3-F + SP, 10A
SC40C 550T	L 5.5kW	R-S 3-F + SP, 10A
SC40C 750T	L 7.5kW	R-S 3-F + SP, 10A
SC46A 750T	L 7.5kW	R-S 3-F + SP, 10A
SC46A 1100T	L 11.0kW	R-S 3-F + SP, 16A
SC46C 750T	L 7.5kW	R-S 3-F + SP, 10A
SC46C 1100T	L 11.0kW	R-S 3-F + SP, 16A
SC50A 750T	L 7.5kW	R-S 3-F + SP, 10A
SC50A 1100T	L 11.0kW	R-S 3-F + SP, 16A
SC50A 1500T	L 15.0kW	R-S 3-F + SP, 16A
SC50C 750T	L 7.5kW	R-S 3-F + SP, 10A
SC50C 1100T	L 11.0kW	R-S 3-F + SP, 16A
SC50C 1500T	L 15.0kW	R-S 3-F + SP, 16A

Wentylator	rozłącznik serwisowy
SC10A 037S	R-S 1-F + SP, 10A
SC10A 055S	R-S 1-F + SP, 10A
SC10C 075S	R-S 1-F + SP, 10A
SC20A 110S	R-S 1-F + SP, 10A
SC20A 150S	R-S 1-F + SP, 10A
SC20C 110S	R-S 1-F + SP, 10A
SC20C 150S	R-S 1-F + SP, 10A
SC30A 220S	R-S 1-F, 10A

Numery artykułów

L 0.4kW	40016302	L 5.5kW	40016362
L 0.75kW	40016312	L 7.5kW	40016372
L 1.5kW	40016322	R-S 1-F, 10A	91040907
L 11.0kW	40016382	R-S 1-F + SP, 10A	91040907-01
L 15.0kW	40016392	R-S 3-F + SP, 10A	91040908-01
L 2.2kW	40016332	R-S 3-F + SP, 16A	91040908
L 4.0kW	40016352		

