



VENT 100-315 NK



VENT 355-400

## ZASTOSOWANIE

Wentylator przeznaczony do wszelkiego rodzaju instalacji wentylacji ogólnej. Typowe zastosowania to:

- wentylacja wywiewna i nawiewna mieszkań, biur, sklepów, lokali gastronomicznych,
- układy chłodzące,
- nadmuchiwanie postaci reklamowych.

## KONSTRUKCJA

- obudowa z galwanizowanej blachy stalowej (modele od 100NK do 315NK),
- obudowa z blachy stalowej zabezpieczonej przed korozją poprzez malowanie katalforetyczne farbą podkładową oraz farbą poliesterową (modele 355N i 400N),
- wirnik z tworzywa sztucznego (modele od 100NK do 315NK),
- wirnik z blachy aluminiowej (modele 355N i 400N),
- puszka przyłączeniowa na obudowie,
- wspornik montażowy w zestawie (w modelach od 100NK do 315NK),
- możliwość montażu w pozycji pionowej i poziomej.

## SILNIK ELEKTRYCZNY

- silniki jednofazowe z wirującym stojanem 230V, 50/60Hz (modele od 100NK do 400N),
- silniki trójfazowe 230/400V, 50Hz (modele 355N-T 400N-T),
- stopień ochrony IP44, klasa izolacji uzwojenia B (modele od 100NK do 250NK),
- stopień ochrony IP44, klasa izolacji uzwojenia F (model 315NK),
- stopień ochrony IP54, klasa izolacji uzwojenia F (modele 355N i 400N),
- łożyska kulkowe,
- do regulacji napięciowej (silniki jednofazowe),
- do regulacji częstotliwościowej (silniki trójfazowe),
- termiczne zabezpieczenie uzwojenia przed przeciążeniem.



Wspornik montażowy w standardzie



## DANE TECHNICZNE

Typ	napięcie [V]	prędkość obrotowa [obr./min]	pobór mocy max [W]	nateżenie [A]	wydajność max [m³/h]	poziom ciśnienia akust.*			temp. pracy min   max [°C]	masa [kg]	regulator	ErP	nr artykułu
						wlot	wylot	emit.					
						[dB(A)]							
VENT-100NK	230	2600	61	0,3	290	56	54	44	-20   +60	3	VREB 1,5H RVS-1,5	2018	40020893
VENT-125NK	230	2620	60	0,3	390	57	54	42	-20   +60	3	VREB 1,5H RVS-1,5	2018	40020894
VENT-150NK	230	2550	95	0,4	750	59	56	42	-20   +60	5	VREB 1,5H RVS-1,5	2018	40020895
VENT-160NK	230	2560	96	0,4	760	59	55	42	-20   +60	5	VREB 1,5H RVS-1,5	2018	40020896
VENT-200NK	230	2720	147	0,6	970	60	58	43	-20   +60	5	VREB 1,5H RVS-1,5	2018	40020897
VENT-250NK	230	2720	149	0,6	1030	62	61	50	-20   +60	6	VREB 1,5H RVS-1,5	2018	40020898
VENT-315NK	230	2790	257	1,1	1370	65	64	48	-20   +60	8	VREB 1,5H RVS-1,5	2018	40020899
VENT-355N	230	1404	287	1,2	2690	58	61	40	-40   +70	18,8	VREB 1,5H RVS-1,5	2018	40022216
VENT-400N	230	1380	536	2,3	3820	59	63	49	-40   +50	22,2	REB 5 RVS-3	2018	40022217
VENT-355N T	230/400	1400	290	1,4/0,8	2690	58	61	40	-40   +70	17	Falownik 0,4kW	2018	40022230
VENT-400N T	230/400	1400	450	1,9/1,1	3820	59	63	49	-40   +50	22	Falownik 0,4kW	2018	40022231

\* pomiar z odległości 1,5m od wentylatora, przy maksymalnej wydajności.

## CHARAKTERYSTYKI PRACY

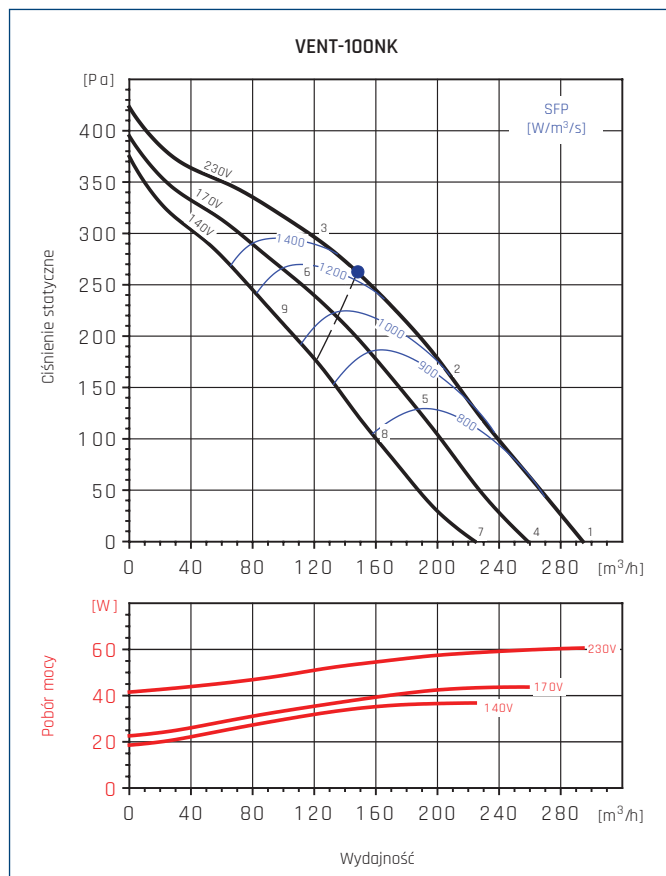

• - punkt najwyższej sprawności wentylatora.

## CHARAKTERYSTYKA AKUSTYCZNA

Hz/dB(A)	63	125	250	500	1000	2000	4000	8000	L <sub>WA</sub>	
1	Wlot	37	46	58	62	68	64	60	45	71
	Wylot	37	45	63	58	63	61	57	46	68
	Emitowany	33	38	50	50	55	49	51	37	59
2	Wlot	39	45	56	60	66	62	56	43	69
	Wylot	38	44	61	56	61	59	54	43	66
	Emitowany	35	37	48	48	53	47	47	34	56
3	Wlot	37	43	53	58	65	60	53	42	67
	Wylot	37	43	57	56	60	57	52	42	64
	Emitowany	33	35	45	46	52	45	44	33	55
4	Wlot	35	43	55	59	65	61	56	41	68
	Wylot	35	42	60	55	60	58	53	41	65
	Emitowany	31	35	47	47	52	46	47	32	55
5	Wlot	36	42	54	57	63	60	52	39	66
	Wylot	36	42	59	53	58	56	50	39	63
	Emitowany	32	34	46	45	50	45	43	30	54
6	Wlot	34	40	52	56	63	58	50	39	65
	Wylot	35	41	56	53	58	55	49	40	62
	Emitowany	30	32	44	44	50	43	41	30	53
7	Wlot	32	39	51	55	60	57	49	34	63
	Wylot	31	39	56	50	55	53	46	34	60
	Emitowany	28	31	43	43	47	42	40	25	51
8	Wlot	32	38	49	53	59	55	45	32	62
	Wylot	32	39	54	49	54	51	44	32	59
	Emitowany	28	30	41	41	46	40	36	23	49
9	Wlot	32	37	49	52	61	55	46	35	63
	Wylot	32	39	54	50	56	52	45	35	60
	Emitowany	28	29	41	40	48	40	37	26	50

## CHARAKTERYSTYKI PRACY

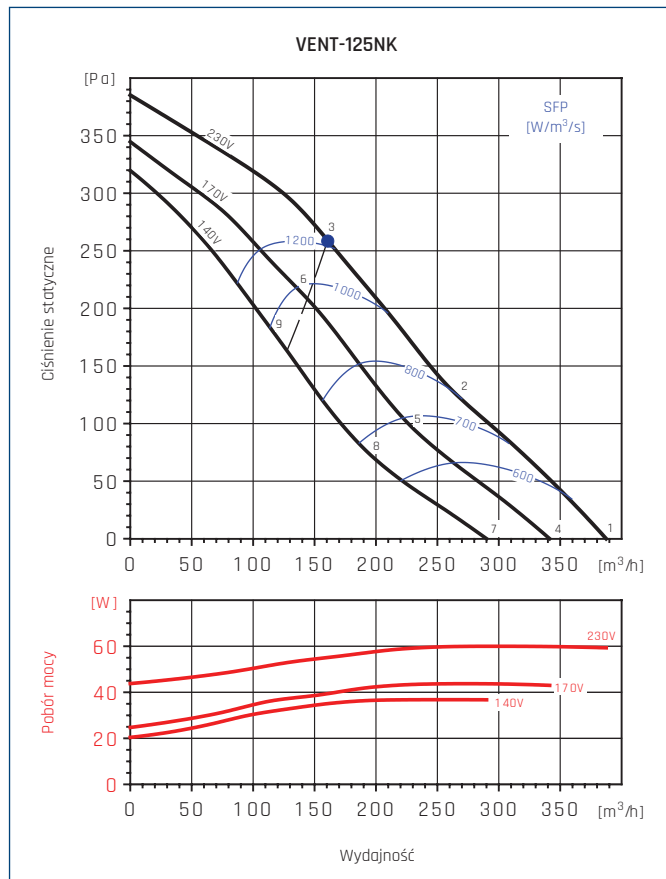

● - punkt najwyższej sprawności wentylatora.

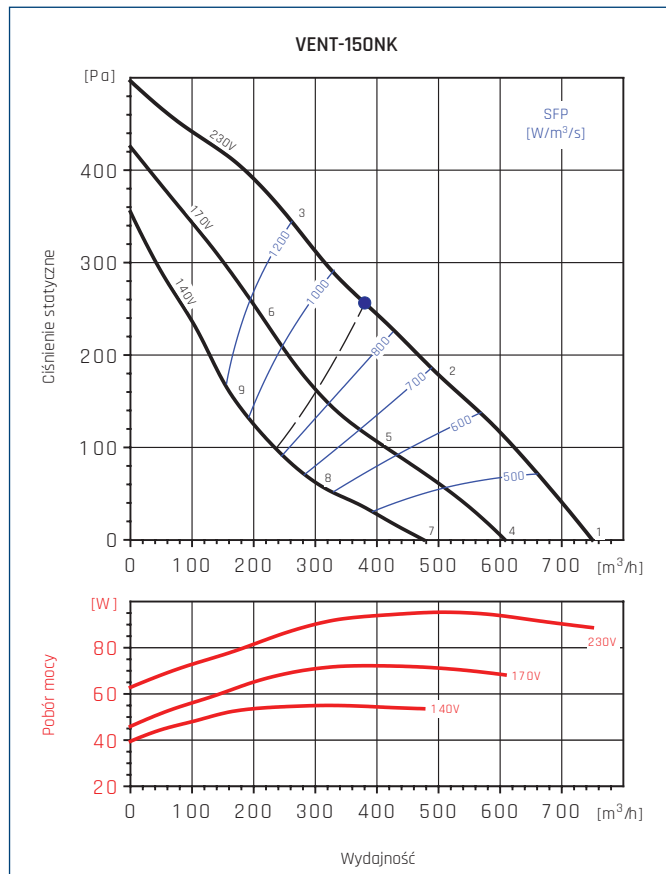

● - punkt najwyższej sprawności wentylatora.

## CHARAKTERYSTYKA AKUSTYCZNA

Hz/dB(A)	63	125	250	500	1000	2000	4000	8000	L <sub>WA</sub>	
1	Wlot	33	42	54	64	67	66	62	49	71
	Wylot	33	43	61	62	63	62	59	47	69
	Emitowany	20	34	49	45	53	49	50	37	57
2	Wlot	34	42	53	64	66	64	58	47	70
	Wylot	34	43	59	62	62	60	56	45	67
	Emitowany	21	34	48	45	52	47	46	35	55
3	Wlot	35	43	53	64	65	61	54	43	69
	Wylot	35	44	60	62	61	58	53	44	67
	Emitowany	22	35	48	45	51	44	42	31	54
4	Wlot	31	40	52	62	65	64	60	47	69
	Wylot	31	41	59	60	61	60	57	45	66
	Emitowany	18	32	47	43	51	47	48	35	55
5	Wlot	32	40	51	62	64	62	56	45	67
	Wylot	31	40	56	59	59	57	53	42	65
	Emitowany	19	32	46	43	50	45	44	33	53
6	Wlot	33	41	51	62	63	59	52	41	67
	Wylot	33	42	58	60	59	56	51	42	65
	Emitowany	20	33	46	43	49	42	40	29	53
7	Wlot	27	36	48	58	61	60	56	43	66
	Wylot	27	37	55	56	57	56	53	41	63
	Emitowany	14	28	43	39	47	43	44	31	51
8	Wlot	28	36	47	58	60	58	52	41	64
	Wylot	28	37	53	56	56	54	50	39	61
	Emitowany	15	28	42	39	46	41	40	29	49
9	Wlot	31	39	49	60	61	57	50	39	65
	Wylot	31	40	56	58	57	54	49	40	63
	Emitowany	18	31	44	41	47	40	38	27	50

Hz/dB(A)	63	125	250	500	1000	2000	4000	8000	L <sub>WA</sub>	
1	Wlot	37	45	58	69	68	67	63	51	73
	Wylot	37	48	62	63	64	64	61	51	70
	Emitowany	21	37	45	49	50	51	49	37	56
2	Wlot	35	44	58	68	67	65	60	48	72
	Wylot	35	47	59	62	63	63	58	48	69
	Emitowany	19	36	45	48	49	49	46	34	55
3	Wlot	37	48	60	68	66	65	57	47	72
	Wylot	36	49	61	61	62	61	55	46	68
	Emitowany	21	40	47	48	48	49	43	33	55
4	Wlot	33	41	54	65	64	63	59	47	70
	Wylot	33	44	58	59	60	60	57	47	66
	Emitowany	17	33	41	45	46	47	45	33	52
5	Wlot	30	39	53	63	62	60	55	43	67
	Wylot	30	42	54	57	58	58	53	43	64
	Emitowany	14	31	40	43	44	44	41	29	50
6	Wlot	33	44	56	64	62	61	53	43	68
	Wylot	33	46	58	58	59	58	52	43	64
	Emitowany	17	36	43	44	44	45	39	29	51
7	Wlot	28	36	49	60	59	58	54	42	64
	Wylot	28	39	53	54	55	55	52	42	61
	Emitowany	12	28	36	40	41	42	40	28	47
8	Wlot	24	33	47	57	56	54	49	37	62
	Wylot	24	36	48	51	52	52	47	37	58
	Emitowany	8	25	34	37	38	38	35	23	44
9	Wlot	28	39	51	59	57	56	48	38	63
	Wylot	28	41	53	53	54	53	47	38	59
	Emitowany	12	31	38	39	39	40	34	24	46

## CHARAKTERYSTYKI PRACY

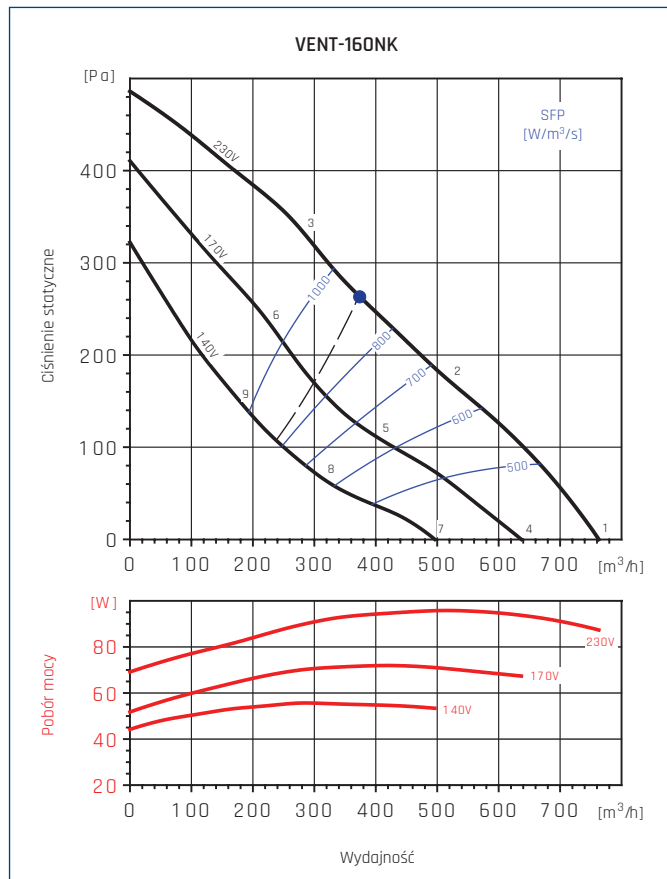

● - punkt najwyższej sprawności wentylatora.

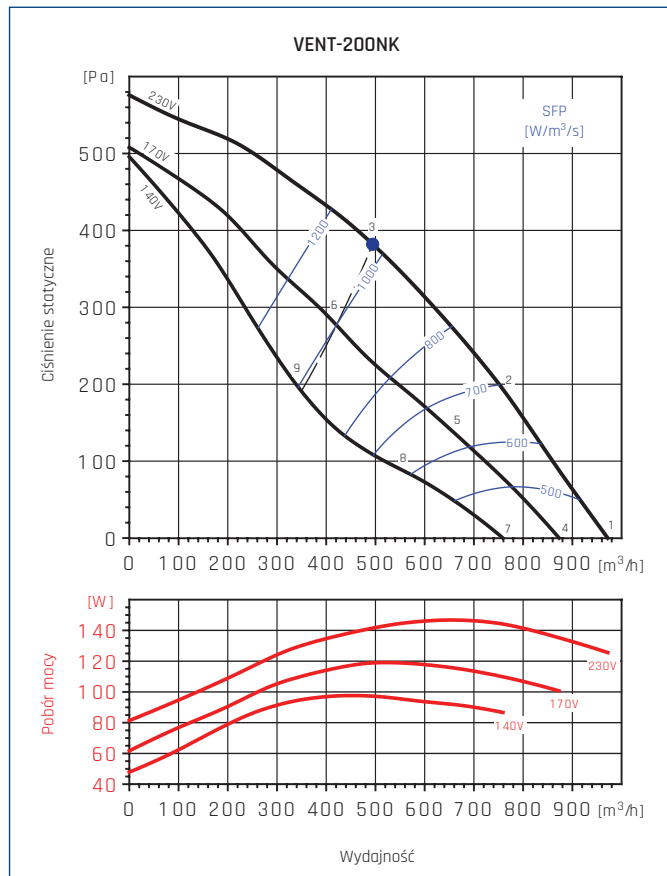

● - punkt najwyższej sprawności wentylatora.

## CHARAKTERYSTYKA AKUSTYCZNA

Hz/dB(A)	63	125	250	500	1000	2000	4000	8000	L <sub>WA</sub>	
1	Wlot	36	45	58	68	67	67	65	53	73
	Wylot	38	47	61	62	64	64	62	52	70
	Emitowany	22	37	46	50	53	52	50	41	58
2	Wlot	33	45	57	68	67	65	61	50	72
	Wylot	34	47	57	63	63	63	58	49	69
	Emitowany	19	37	45	50	53	50	46	38	57
3	Wlot	37	48	58	67	65	64	57	47	71
	Wylot	37	51	62	63	63	61	55	46	69
	Emitowany	23	40	46	49	51	49	42	35	55
4	Wlot	32	41	54	64	63	63	61	49	69
	Wylot	34	43	57	58	60	60	58	48	66
	Emitowany	18	33	42	46	49	48	46	37	54
5	Wlot	28	40	52	63	62	60	56	45	67
	Wylot	29	42	52	58	58	58	53	44	64
	Emitowany	14	32	40	45	48	45	41	33	52
6	Wlot	33	44	54	63	61	60	53	43	67
	Wylot	33	47	58	59	59	57	51	42	65
	Emitowany	19	36	42	45	47	45	38	31	51
7	Wlot	27	36	49	59	58	58	56	44	64
	Wylot	29	38	52	53	55	55	53	43	61
	Emitowany	13	28	37	41	44	43	41	32	49
8	Wlot	22	34	46	57	56	54	50	39	62
	Wylot	24	37	47	53	53	53	48	39	58
	Emitowany	8	26	34	39	42	39	35	27	46
9	Wlot	28	39	49	58	56	55	48	38	62
	Wylot	28	42	53	54	54	52	46	37	60
	Emitowany	14	31	37	40	42	40	33	26	47

Hz/dB(A)	63	125	250	500	1000	2000	4000	8000	L <sub>WA</sub>	
1	Wlot	38	48	63	67	70	68	65	53	75
	Wylot	37	47	61	63	67	67	65	52	73
	Emitowany	36	39	44	38	48	52	54	48	58
2	Wlot	36	46	62	64	67	64	61	55	71
	Wylot	37	46	62	61	63	63	61	54	69
	Emitowany	34	37	43	35	45	48	50	40	54
3	Wlot	37	46	60	63	65	62	57	50	69
	Wylot	35	46	61	59	62	62	58	50	68
	Emitowany	35	37	41	34	43	46	46	35	51
4	Wlot	36	46	61	65	68	66	63	61	73
	Wylot	36	46	60	62	66	66	64	61	71
	Emitowany	34	37	42	36	46	50	52	46	56
5	Wlot	33	43	59	61	64	61	58	52	68
	Wylot	34	43	59	58	60	60	58	51	66
	Emitowany	31	34	40	32	42	45	47	37	51
6	Wlot	34	43	57	60	62	59	54	47	67
	Wylot	32	43	58	56	59	59	55	47	65
	Emitowany	32	34	38	31	40	43	43	32	48
7	Wlot	33	43	58	62	65	63	60	58	70
	Wylot	32	42	56	58	62	62	60	57	68
	Emitowany	31	34	39	33	43	47	49	43	53
8	Wlot	29	39	55	57	60	57	54	48	64
	Wylot	30	39	55	54	56	56	54	47	62
	Emitowany	27	30	36	28	38	41	43	33	47
9	Wlot	30	39	53	56	58	55	50	43	63
	Wylot	28	39	54	52	55	55	51	43	61
	Emitowany	28	30	34	27	36	39	39	28	44

## CHARAKTERYSTYKI PRACY

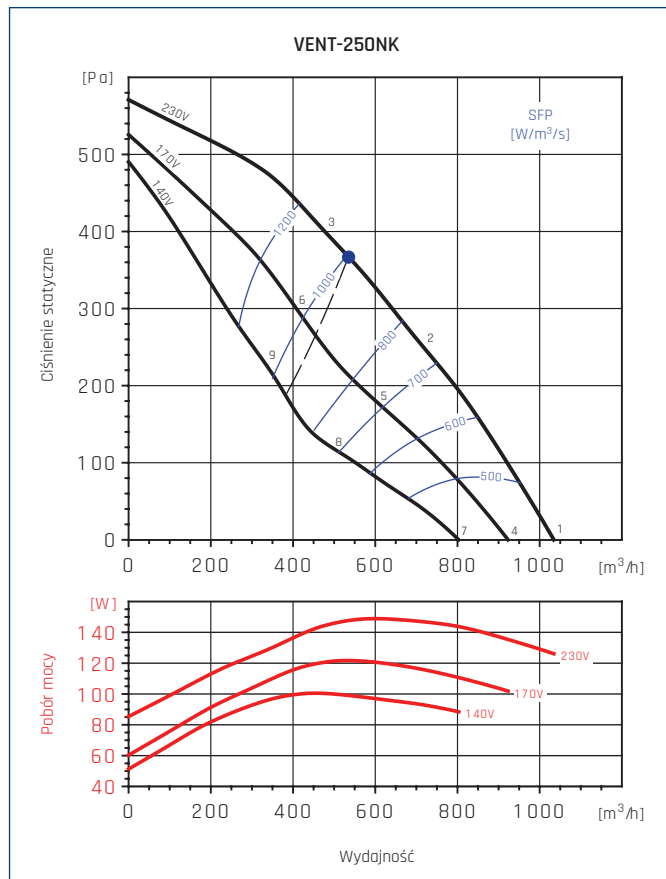

● - punkt najwyższej sprawności wentylatora.

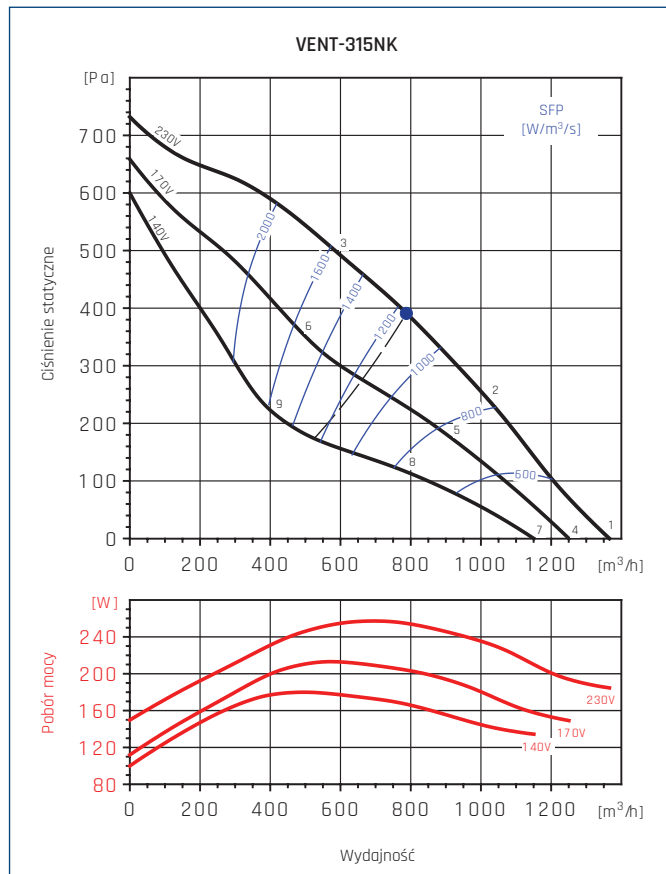

● - punkt najwyższej sprawności wentylatora.

## CHARAKTERYSTYKA AKUSTYCZNA

Hz/dB(A)	63	125	250	500	1000	2000	4000	8000	L <sub>WA</sub>	
1	Wlot	37	48	65	68	72	70	68	65	77
	Wylot	40	51	66	67	69	69	69	66	76
	Emitowany	22	39	49	50	58	59	59	56	64
2	Wlot	36	46	63	64	68	66	66	59	73
	Wylot	39	49	63	63	65	64	66	59	72
	Emitowany	21	37	47	46	54	55	57	50	61
3	Wlot	35	43	61	61	66	63	62	54	70
	Wylot	37	46	62	62	65	64	62	55	70
	Emitowany	20	34	45	43	52	52	53	45	58
4	Wlot	35	46	63	66	70	68	66	63	74
	Wylot	38	49	64	65	67	67	67	64	74
	Emitowany	20	37	47	48	56	57	57	54	62
5	Wlot	33	43	60	61	65	63	63	56	70
	Wylot	36	46	60	60	62	61	63	56	69
	Emitowany	18	34	44	43	51	52	54	47	58
6	Wlot	32	40	58	58	63	60	59	51	67
	Wylot	34	43	59	59	62	61	59	52	67
	Emitowany	17	31	42	40	49	49	50	42	55
7	Wlot	32	43	60	63	67	65	63	60	72
	Wylot	35	46	61	62	64	64	64	61	71
	Emitowany	17	34	44	45	53	54	54	51	60
8	Wlot	29	39	56	57	61	59	59	52	66
	Wylot	32	42	56	56	58	57	59	52	64
	Emitowany	14	30	40	39	47	48	50	43	54
9	Wlot	28	36	54	54	59	56	55	47	63
	Wylot	30	39	55	55	58	57	55	48	64
	Emitowany	13	27	38	36	45	45	46	38	51

Hz/dB(A)	63	125	250	500	1000	2000	4000	8000	L <sub>WA</sub>	
1	Wlot	39	53	67	73	76	71	68	67	79
	Wylot	48	54	69	71	75	74	70	70	80
	Emitowany	29	33	45	51	58	57	55	54	63
2	Wlot	38	55	67	73	73	69	67	63	78
	Wylot	49	55	70	71	74	72	69	64	79
	Emitowany	28	35	45	51	55	55	54	50	61
3	Wlot	42	64	71	73	74	70	67	60	79
	Wylot	50	64	74	71	74	72	68	62	80
	Emitowany	32	44	49	51	56	56	54	47	61
4	Wlot	38	52	66	72	75	70	67	66	78
	Wylot	47	53	68	70	74	73	69	69	79
	Emitowany	28	32	44	50	57	56	54	53	61
5	Wlot	36	53	65	71	71	67	65	61	75
	Wylot	46	52	67	68	71	69	66	61	76
	Emitowany	26	33	43	49	53	53	52	48	58
6	Wlot	39	61	68	70	71	67	64	57	76
	Wylot	47	61	71	68	71	69	65	59	76
	Emitowany	29	41	46	48	53	53	51	44	58
7	Wlot	36	50	64	70	73	68	65	64	76
	Wylot	45	51	66	68	72	71	67	67	77
	Emitowany	26	30	42	48	55	54	52	51	59
8	Wlot	31	48	60	66	66	62	60	56	71
	Wylot	42	48	63	64	67	65	62	57	72
	Emitowany	21	28	38	44	48	48	47	43	54
9	Wlot	34	56	63	65	66	62	59	52	71
	Wylot	42	56	66	63	66	64	60	54	72
	Emitowany	24	36	41	43	48	48	46	39	53

## CHARAKTERYSTYKI PRACY

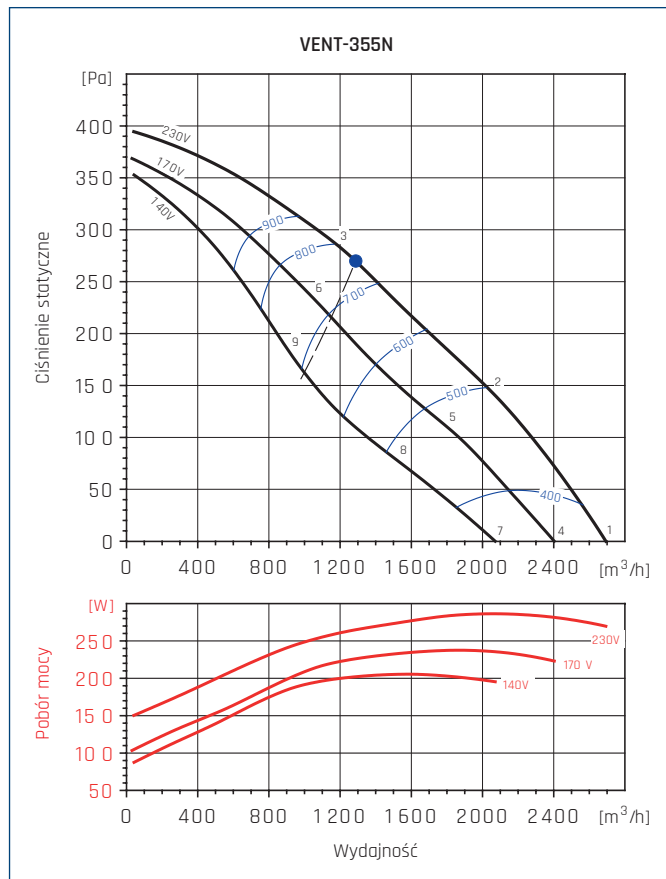

● - punkt najwyższej sprawności wentylatora.

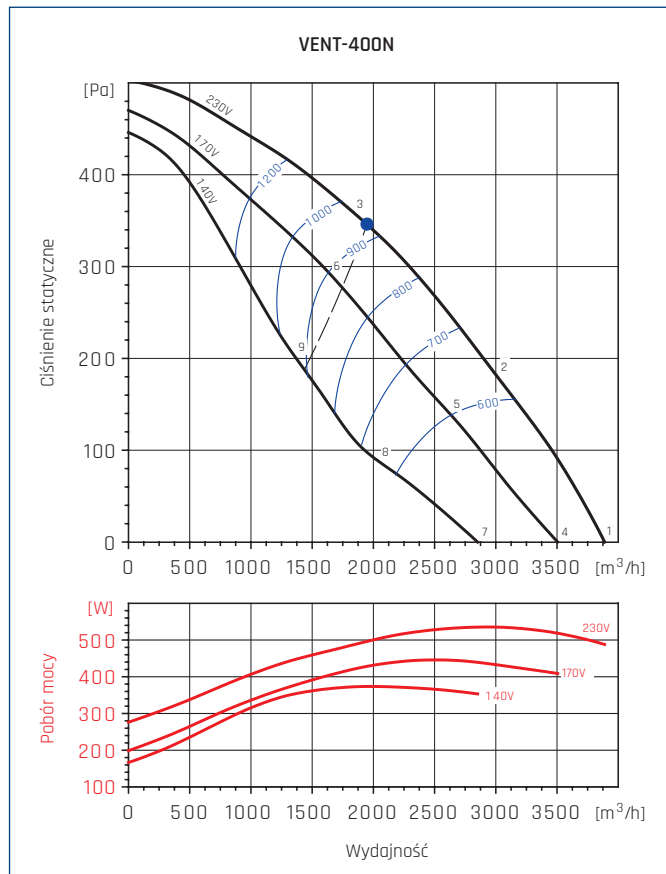

● - punkt najwyższej sprawności wentylatora.

## CHARAKTERYSTYKA AKUSTYCZNA

Hz/dB(A)		63	125	250	500	1000	2000	4000	8000	L <sub>WA</sub>
1	Wlot	43	60	65	67	67	62	61	48	72
	Wylot	42	57	64	70	71	68	61	50	75
	Emitowany	34	50	47	47	49	42	40	28	55
2	Wlot	39	57	63	65	66	60	57	48	70
	Wylot	39	55	64	70	69	66	58	49	74
	Emitowany	30	47	45	45	48	40	36	28	53
3	Wlot	44	59	66	67	67	60	57	48	72
	Wylot	42	56	65	71	69	66	59	50	75
	Emitowany	35	49	48	47	49	40	36	28	55
4	Wlot	41	58	63	65	65	60	59	46	70
	Wylot	40	55	62	68	69	66	59	48	73
	Emitowany	32	48	45	45	47	40	38	26	53
5	Wlot	37	55	61	63	64	58	55	46	68
	Wylot	37	53	62	68	67	64	56	47	72
	Emitowany	28	45	43	43	46	38	34	26	50
6	Wlot	42	57	64	65	65	58	55	46	70
	Wylot	40	54	63	69	67	64	57	48	73
	Emitowany	33	47	46	45	47	38	34	26	53
7	Wlot	38	55	60	62	62	57	56	43	67
	Wylot	37	52	59	65	66	63	56	45	70
	Emitowany	29	45	42	42	44	37	35	23	50
8	Wlot	33	51	57	59	60	54	51	42	65
	Wylot	33	49	58	64	63	60	52	43	68
	Emitowany	24	41	39	39	42	34	30	22	47
9	Wlot	39	54	61	62	62	55	52	43	67
	Wylot	37	51	60	66	64	61	54	45	70
	Emitowany	30	44	43	42	44	35	31	23	50

Hz/dB(A)		63	125	250	500	1000	2000	4000	8000	L <sub>WA</sub>
1	Wlot	47	61	65	69	67	64	61	53	73
	Wylot	52	68	68	72	73	69	61	54	78
	Emitowany	38	56	53	57	59	52	46	40	63
2	Wlot	43	58	62	64	64	62	57	50	70
	Wylot	44	66	64	67	69	65	57	49	74
	Emitowany	34	53	50	52	56	50	42	37	60
3	Wlot	46	60	64	66	64	60	55	50	71
	Wylot	47	65	65	68	68	63	55	47	73
	Emitowany	37	55	52	54	56	48	40	37	61
4	Wlot	45	59	63	67	65	62	59	51	71
	Wylot	50	66	66	70	71	67	59	52	76
	Emitowany	36	54	51	55	57	50	44	38	61
5	Wlot	40	55	59	61	61	59	54	47	67
	Wylot	41	63	61	64	66	62	54	46	71
	Emitowany	31	50	47	49	53	47	39	34	57
6	Wlot	44	58	62	64	62	58	53	48	69
	Wylot	45	63	63	66	66	61	53	45	71
	Emitowany	35	53	50	52	54	46	38	35	59
7	Wlot	41	55	59	63	61	58	55	47	67
	Wylot	46	62	62	66	67	63	55	48	72
	Emitowany	32	50	47	51	53	46	40	34	57
8	Wlot	35	50	54	56	56	54	49	42	62
	Wylot	36	58	56	59	61	57	49	41	66
	Emitowany	26	45	42	44	48	42	34	29	52
9	Wlot	40	54	58	60	58	54	49	44	65
	Wylot	41	59	59	62	62	57	49	41	67
	Emitowany	31	49	46	48	50	42	34	31	55

## CHARAKTERYSTYKI PRACY

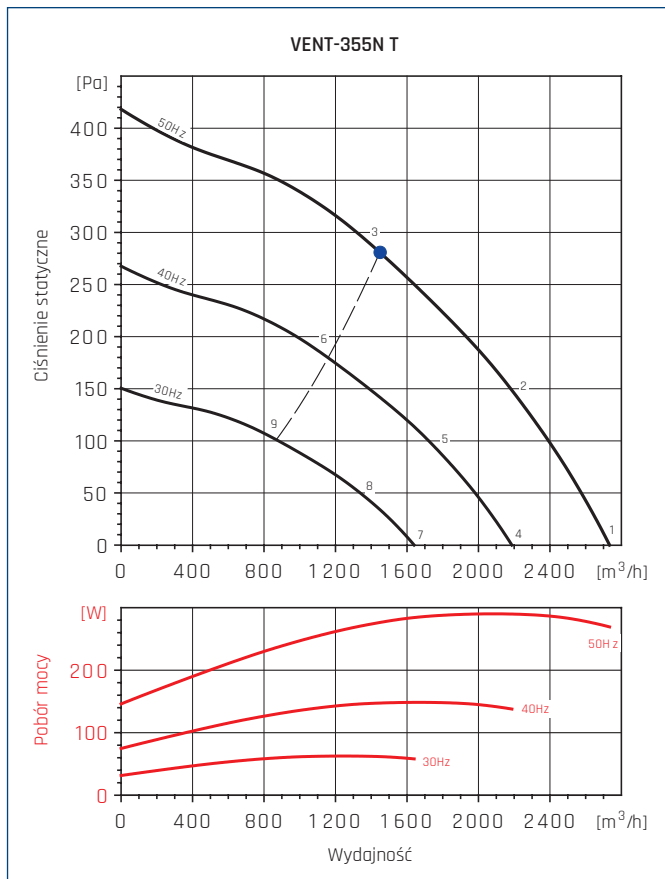

● - punkt najwyższej sprawności wentylatora.

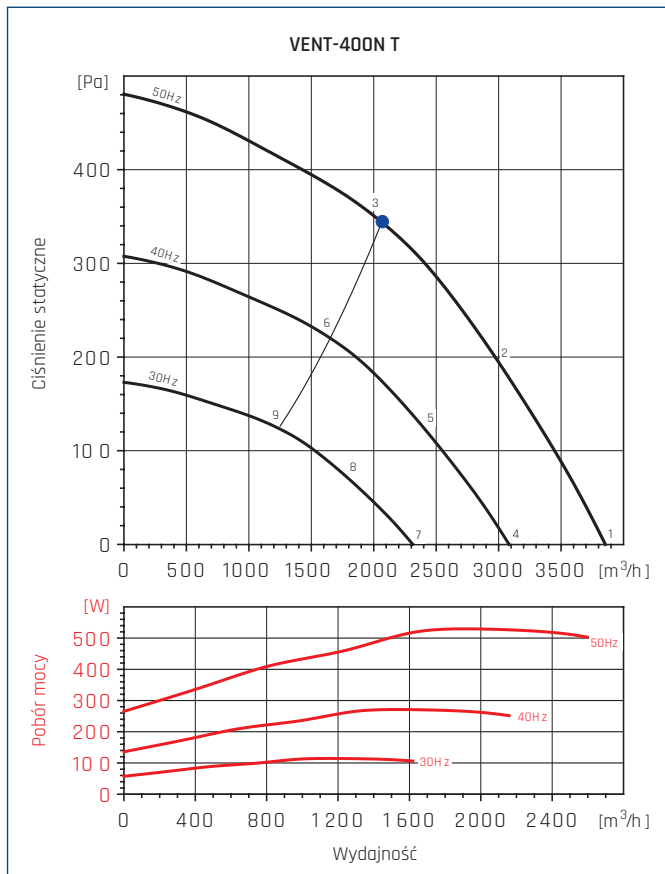

● - punkt najwyższej sprawności wentylatora.

## CHARAKTERYSTYKA AKUSTYCZNA

Hz/dB(A)	63	125	250	500	1000	2000	4000	8000	L <sub>WA</sub>	
1	Wlot	43	60	65	67	67	62	61	48	72
	Wylot	42	57	64	70	71	68	61	50	75
	Emitowany	34	50	47	47	49	42	40	28	55
2	Wlot	39	57	63	65	66	60	57	48	70
	Wylot	39	55	64	70	69	66	58	49	74
	Emitowany	30	47	45	45	48	40	36	28	53
3	Wlot	44	59	66	67	67	60	57	48	72
	Wylot	42	56	65	71	69	66	59	50	75
	Emitowany	35	49	48	47	49	40	36	28	55
4	Wlot	38	55	60	62	62	57	56	43	67
	Wylot	37	52	59	65	66	63	56	45	70
	Emitowany	29	45	42	42	44	37	35	23	50
5	Wlot	34	52	58	60	61	55	52	43	66
	Wylot	34	50	59	65	64	61	53	44	69
	Emitowany	25	42	40	40	43	35	31	23	48
6	Wlot	39	54	61	62	62	55	52	43	67
	Wylot	37	51	60	66	64	61	54	45	70
	Emitowany	30	44	43	42	44	35	31	23	50
7	Wlot	32	49	54	56	56	51	50	37	61
	Wylot	31	46	53	59	60	57	50	39	64
	Emitowany	23	39	36	36	38	31	29	17	44
8	Wlot	28	46	52	54	55	49	46	37	59
	Wylot	28	44	53	59	58	55	47	38	63
	Emitowany	19	36	34	34	37	29	25	17	42
9	Wlot	33	48	55	56	56	49	46	37	61
	Wylot	31	45	54	60	58	55	48	39	64
	Emitowany	24	38	37	36	38	29	25	17	44

Hz/dB(A)	63	125	250	500	1000	2000	4000	8000	L <sub>WA</sub>	
1	Wlot	47	61	65	69	67	64	61	53	73
	Wylot	52	68	68	72	73	69	61	54	78
	Emitowany	38	56	53	57	59	52	46	40	63
2	Wlot	43	58	62	64	64	62	57	50	70
	Wylot	44	66	64	67	69	65	57	49	74
	Emitowany	34	53	50	52	56	50	42	37	60
3	Wlot	46	60	64	66	64	60	55	50	71
	Wylot	47	65	65	68	68	63	55	47	73
	Emitowany	37	55	52	54	56	48	40	37	61
4	Wlot	42	56	60	64	62	59	56	48	68
	Wylot	47	63	63	67	68	64	56	49	73
	Emitowany	33	51	48	52	54	47	41	35	58
5	Wlot	38	53	57	59	59	57	52	45	65
	Wylot	39	61	59	62	64	60	52	44	69
	Emitowany	29	48	45	47	51	45	37	32	55
6	Wlot	41	55	59	61	59	55	50	45	66
	Wylot	42	60	60	63	63	58	50	42	68
	Emitowany	32	50	47	49	51	43	35	32	56
7	Wlot	36	50	54	58	56	53	50	42	62
	Wylot	41	57	57	61	62	58	50	43	67
	Emitowany	27	45	42	46	48	41	35	29	52
8	Wlot	32	47	51	53	53	51	46	39	59
	Wylot	33	55	53	56	58	54	46	38	63
	Emitowany	23	42	39	41	45	39	31	26	49
9	Wlot	35	49	53	55	53	49	44	39	59
	Wylot	36	54	54	57	57	52	44	36	62
	Emitowany	26	44	41	43	45	37	29	26	50

## WYMIARY [mm]

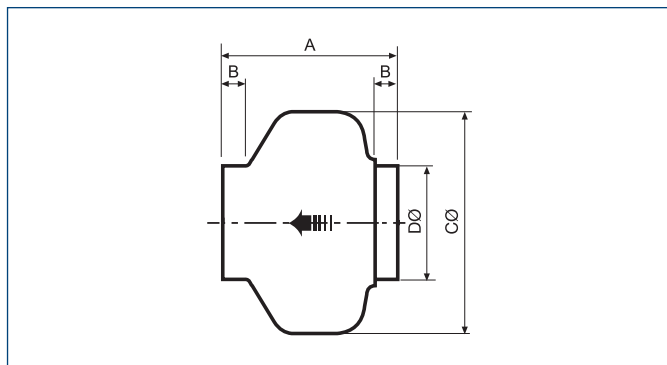

Typ	A	B	ØC	ØD
VENT-100 NK	195	23	243	98
VENT-125 NK	197	27	243	123
VENT-150 NK	213	22	333	147
VENT-160 NK	220	27	333	157
VENT-200 NK	223	25	333	198
VENT-250 NK	205	27	333	248
VENT-315 NK	232	25	401	312

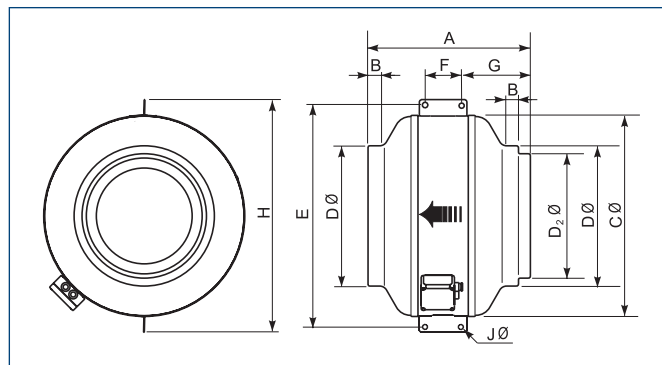

Typ	A	B	ØC	ØD	ØD <sub>2</sub>	E	F	G	H	ØJ
VENT-355 N	410	25	508	354	314	552	100	170	587	10,5
VENT-400 N	431	25	568	399	354	628	100	185	647	10,5



## AKCESORIA MONTAŻOWE



1 Wentylator	2 filtr kanałowy DF	3 filtr kanałowy DF-K				
		wkład filtracyjny do DF-K				
		EU3	EU5	EU7	EU9	
VENT-100NK	DF 100	DF-K 100	EU3   100-250mm	EU5   100-250mm	EU7   100-250mm	EU9   100-250mm
VENT-125NK	DF 125	DF-K 125	EU3   100-250mm	EU5   100-250mm	EU7   100-250mm	EU9   100-250mm
VENT-150NK	DF 160*	DF-K 160*	EU3   100-250mm*	EU5   100-250mm*	EU7   100-250mm*	EU9   100-250mm*
VENT-160NK	DF 160	DF-K 160	EU3   100-250mm	EU5   100-250mm	EU7   100-250mm	EU9   100-250mm
VENT-200NK	DF 200	DF-K 200	EU3   100-250mm	EU5   100-250mm	EU7   100-250mm	EU9   100-250mm
VENT-250NK	DF 250	DF-K 250	EU3   100-250mm	EU5   100-250mm	EU7   100-250mm	EU9   100-250mm
VENT-315NK	DF 315	DF-K 315	EU3   315-450mm	EU5   315-450mm	EU7   315-450mm	-
VENT-355N	DF 355	DF-K 355	EU3   315-450mm	EU5   315-450mm	EU7   315-450mm	-
VENT-400N	DF 400	DF-K 400	EU3   315-450mm	EU5   315-450mm	EU7   315-450mm	-

1 Wentylator	4 klapa zwrotna CAR-PL	5 złącze p. drg. ACOP PL	6 tłumik akustyczny AKU-COMP		7 przepustnica soczewk. IRIS	8 kratka wentylacyjna KWO	9 siatka ochronna DEF-VENT
			0,6m	1,2m			
VENT-100NK	CAR-PL 100	ACOP PL 100	AKU-COMP 100/0.6	AKU-COMP 100/1.2	IRIS 100	KWO 100	DEF-VENT-100
VENT-125NK	CAR-PL 125	ACOP PL 125	AKU-COMP 125/0.6	AKU-COMP 125/1.2	IRIS 125	KWO 125	DEF-VENT-125
VENT-150NK	CAR-PL 150	ACOP PL 150	AKU-COMP 160/0.6*	AKU-COMP 160/1.2*	IRIS 160*	KWO 160*	DEF-VENT-160*
VENT-160NK	CAR-PL 160	ACOP PL 160	AKU-COMP 160/0.6	AKU-COMP 160/1.2	IRIS 160	KWO 160	DEF-VENT-160
VENT-200NK	CAR-PL 200	ACOP PL 200	AKU-COMP 200/0.6	AKU-COMP 200/1.2	IRIS 200	KWO 200	DEF-VENT-200
VENT-250NK	CAR-PL 250	ACOP PL 250	AKU-COMP 250/0.6	AKU-COMP 250/1.2	IRIS 250	KWO 250	DEF-VENT-250
VENT-315NK	CAR-PL 315	ACOP PL 315	AKU-COMP 315/0.6	AKU-COMP 315/1.2	IRIS 315	KWO 315	DEF-VENT-315
VENT-355N	CAR-PL 355	ACOP PL 355	-	-	-	-	AFK 355
VENT-400N	CAR-PL 400	ACOP PL 400	-	-	IRIS 400	KWO 400	AFK 400

\* akcesoria montażowe dedykowane do średnicy 160mm

## Numery artykułów

ACOP PL 100	40521810	AKU-COMP 200/0.6	40521540	DEF-VENT-100	40522010	DF-K 100	40521710	IRIS 100	19527100
ACOP PL 125	40521815	AKU-COMP 200/1.2	40521640	DEF-VENT-125	40522011	DF-K 125	40521715	IRIS 125	19527125
ACOP PL 150	40521818	AKU-COMP 250/0.6	40521550	DEF-VENT-160	40522012	DF-K 200	40521725	IRIS 200	19527200
ACOP PL 160	40521820	AKU-COMP 250/1.2	40521650	DEF-VENT-200	40522013	DF-K 250	40521730	IRIS 250	19527250
ACOP PL 200	40521825	AKU-COMP 315/0.6	40521560	DEF-VENT-250	40522014	DF-K 315	40521735	IRIS 315	19527315
ACOP PL 250	40521830	AKU-COMP 315/1.2	40521660	DEF-VENT-315	40522015	DF-K 355	40521740	IRIS 400	19527400
ACOP PL 315	40521835	CAR-PL 100	40521010-01	AFK 355	40522133	DF-K 400	40521745	KWO 100	40522520
ACOP PL 355	40521840	CAR-PL 125	40521020-01	AFK 400	40522134	EU3   100-250mm	40520800	KWO 125	40522530
ACOP PL 400	40521845	CAR-PL 150	40521029-01	DF 100	40520610	EU3   315-450mm	40520830	KWO 160	40522540
AKU-COMP 100/0.6	40521510	CAR-PL 160	40521030-01	DF 125	40520620	EU5   100-250mm	40520805	KWO 200	40522550
AKU-COMP 100/1.2	40521510	CAR-PL 200	40521040-01	DF 160	40520630	EU5   315-450mm	40520835	KWO 250	40522560
AKU-COMP 125/0.6	40521520	CAR-PL 250	40521050-01	DF 200	40520640	EU7   100-250mm	40520810	KWO 315	40522570
AKU-COMP 125/1.2	40521520	CAR-PL 315	40521060-01	DF 250	40520650	EU7   315-450mm	40520840	KWO 400	40522580
AKU-COMP 160/0.6	40521530	CAR-PL 355	40521065-01	DF 315	40520660	EU9   100-250mm	40520820		
AKU-COMP 160/1.2	40521530	CAR-PL 400	40521070-01	DF-K 160	40521720	IRIS 160	19527160		



## AKCESORIA ELEKTRYCZNE

Wentylator	termostat ścienny	termostat kanałowy	termostat	czujnik przewodowy do TK-21	czujnik zanieczyszczeń	higrostat	regulator tyrystorowy		
	TS	TK-1	TK-21	czujnik temperatury	SQA	HIG-2	REB N	REB NE	VREB
VENT-100NK	TS	TK-1	TK-21	3 MB DO TK-21	SQA	HIG-2	REB-1 N	REB-1 NE	VREB 1,5H
VENT-125NK	TS	TK-1	TK-21	3 MB DO TK-21	SQA	HIG-2	REB-1 N	REB-1 NE	VREB 1,5H
VENT-150NK	TS	TK-1	TK-21	3 MB DO TK-21	SQA	HIG-2	REB-1 N	REB-1 NE	VREB 1,5H
VENT-160NK	TS	TK-1	TK-21	3 MB DO TK-21	SQA	HIG-2	REB-1 N	REB-1 NE	VREB 1,5H
VENT-200NK	TS	TK-1	TK-21	3 MB DO TK-21	SQA	HIG-2	REB-1 N	REB-1 NE	VREB 1,5H
VENT-250NK	TS	TK-1	TK-21	3 MB DO TK-21	SQA	HIG-2	REB-1 N	REB-1 NE	VREB 1,5H
VENT-315NK	TS	TK-1	TK-21	3 MB DO TK-21	SQA	HIG-2	REB-2,5 N	REB-2,5 NE	VREB 2,5H
VENT-355N	TS	TK-1	TK-21 + DILM7-10	3 MB DO TK-21	SQA	-	REB-2,5 N	REB-2,5 NE	VREB 2,5H
VENT-400N	-	TK-1	TK-21 + DILM7-10	3 MB DO TK-21	-	-	REB-5	REB-5	-

Wentylator	11-stopniowy regulator tyrystorowy	2-nastawowy 6-biegowy regulator tyrystorowy	regulator transformatorowy		regulator transformatorowy 2-nastawowy	
	IRF	RND-1	RMB	RVS	SC2	SC2A
VENT-100NK	-	RND-1	RMB-1.5	RVS-1.5	SC2-1-15L25	SC2A1-15L25
VENT-125NK	-	RND-1	RMB-1.5	RVS-1.5	SC2-1-15L25	SC2A1-15L25
VENT-150NK	-	RND-1	RMB-1.5	RVS-1.5	SC2-1-15L25	SC2A1-15L25
VENT-160NK	-	RND-1	RMB-1.5	RVS-1.5	SC2-1-15L25	SC2A1-15L25
VENT-200NK	IRF-900	RND-1	RMB-1.5	RVS-1.5	SC2-1-15L25	SC2A1-15L25
VENT-250NK	IRF-900	RND-1	RMB-1.5	RVS-1.5	SC2-1-15L25	SC2A1-15L25
VENT-315NK	IRF-900	RND-1	RMB-1.5	RVS-1.5	SC2-1-15L25	SC2A1-15L25
VENT-355N	IRF-900	RND-1	RMB-1.5	RVS-1.5	SC2-1-15L25	SC2A1-15L25
VENT-400N	IRF-900	-	RMB-3.5	RVS-3	SC2-1-35L25	SC2A1-35L25

Wentylator	falownik
VENT-355N T	L 0,4kW
VENT-400N T	L 0,4kW

## Numery artykułów

DILM7-10	02	REB-1 NE	40025020	RMB-3.5	40025070	SC2-1-35L25	40025254	VREB 1,5H	40025830
3 MB DO TK-21	40025320	REB-2,5 N	40025030	RND-1	40025630	SC2A1-15L25	40025251	VREB 2,5H	40025840
HIG-2	40025150	REB-2,5 NE	40025040	RVS-1.5	40025232	SC2A1-35L25	40025255	TS	40025345
IRF-900	40015154	REB-5	40025051	RVS-3	40025234	SQA	40025140	L 0,4kW	40016302
REB-1 N	40025010	RMB-1.5	40025060	SC2-1-15L25	40025250	TK-1	40025330		



## CHARAKTERYSTYKA ERP

SWM*		
	Nazwa produktu	VENT-100NK
a	Nazwa dostawcy	VENTURE INDUSTRIES / SOLER&PALAU
b	Numer artykułu	40020893
c	JZE umiarkowany (SEC Avarage) [kWh/m <sup>2</sup> rok]	-10,5
c	JZE chłodny (SEC cold)	-26,9
c	JZE ciepły (SEC warm)	-1,1
c	JZE (SEC) klasa	E
d	Kategoria urządzenia	SWM (RVU)
d	Typ urządzenia	JSW (UVU)
e	Napęd	bezstopniowy
f	Typ odzysku ciepła	brak
g	Sprawność temperaturowa [%]	nie dotyczy
h	Maksymalny przepływ powietrza [m <sup>3</sup> /h]	240
i	Maksymalny pobór mocy [W]	59,2
j	Moc akustyczna [dB(A)]	49
k	Wartość odniesienia natężenia przepływu [m <sup>3</sup> /s]	0,047
l	Wartość odniesienia różnicy ciśnienia [Pa]	168
m	JPM/SPI [W/m <sup>3</sup> /h]	0,213
n	CRS/CTRL	1
o	Stopień zewnętrznych przecieków powietrza [%]	
p	Stopień mieszania	nie dotyczy
q	Ostrzeżenia o konieczności wymiany filtra	nie dotyczy
r	Instrukcja instalowania kratki wentylacyjnych	nie dotyczy
s	Strona internetowa	venture.pl / solerpalau.com
t	Podatność przepływu na zmiany ciśnienia	nie dotyczy
u	Szczelność	nie dotyczy
v	Roczne zużycie energii elektrycznej-umiarkowany [kWh/m <sup>2</sup> rok]	266
v	Roczne zużycie energii elektrycznej-chłodny [kWh/m <sup>2</sup> rok]	266
v	Roczne zużycie energii elektrycznej-ciepły [kWh/m <sup>2</sup> rok]	266
w	ROO klimat chłodny	
w	ROO klimat umiarkowany	
w	ROO klimat ciepły	
	MISC	1,1
	x-wykładnik	2

\* SWM-"system wentylacyjny przeznaczony do budynków mieszkalnych"-zgodnie z Rozporządzeniem Komisji (UE) nr 1254/2014

## CHARAKTERYSTYKA ERP

SWNM*					
	Nazwa produktu	VENT-125NK	VENT-150NK	VENT-160NK	VENT-200NK
a	Nazwa dostawcy	VENTURE INDUSTRIES / SOLER&PALAU	VENTURE INDUSTRIES / SOLER&PALAU	VENTURE INDUSTRIES / SOLER&PALAU	VENTURE INDUSTRIES / SOLER&PALAU
b	Numer artykułu	40020894	40020895	40020896	40020897
c	Kategoria urządzenia	SWNM (NRVU)	SWNM (NRVU)	SWNM (NRVU)	SWNM (NRVU)
c	Typ urządzenia	JSW (UVU)	JSW (UVU)	JSW (UVU)	JSW (UVU)
d	Napęd	bezstopniowy	bezstopniowy	bezstopniowy	bezstopniowy
e	Typ odzysku ciepła	brak	brak	brak	brak
f	Sprawność temperaturowa [%]	nie dotyczy	nie dotyczy	nie dotyczy	nie dotyczy
g	Znamionowe natężenie przepływu w SWNM [m³/s]	0,04	0,11	0,1	0,14
h	Efektywny pobór mocy [kW]	0,06	0,09	0,09	0,14
i	JMWint [W/(m³/s)]	nie dotyczy	nie dotyczy	nie dotyczy	nie dotyczy
j	Prędkość czołowa [m/s]	1	1,3	1,2	1,6
k	$\Delta p_s$ , ext [Pa]	260,1	257	264,3	383,1
l	$\Delta p_s$ , int [Pa]	nie dotyczy	nie dotyczy	nie dotyczy	nie dotyczy
m	$\Delta p_s$ , add [Pa]	nie dotyczy	nie dotyczy	nie dotyczy	nie dotyczy
n	Sprawność statyczna wentylatora [%]	26,7	31	31	42,5
o	Stopień zewnętrznych przecieków powietrza [%]	2	2	2	3
p	Stopień wewnętrznych przecieków powietrza [%]	nie dotyczy	nie dotyczy	nie dotyczy	nie dotyczy
q	Efektywność energetyczna filtra	nie dotyczy	nie dotyczy	nie dotyczy	nie dotyczy
r	Ostrzeżenia o konieczności wymiany filtra	nie dotyczy	nie dotyczy	nie dotyczy	nie dotyczy
s	$L_{WA}$ [dB(A)]	54	55	56	51
	Strona internetowa	venture.pl solerpalau.com	venture.pl solerpalau.com	venture.pl solerpalau.com	venture.pl solerpalau.com

SWNM*					
	Nazwa produktu	VENT-250NK	VENT-315NK	VENT-355N	VENT-400N
a	Nazwa dostawcy	VENTURE INDUSTRIES / SOLER&PALAU	VENTURE INDUSTRIES / SOLER&PALAU	VENTURE INDUSTRIES / SOLER&PALAU	VENTURE INDUSTRIES / SOLER&PALAU
b	Numer artykułu	40020898	40020899	40022216	40022217
c	Kategoria urządzenia	SWNM (NRVU)	SWNM (NRVU)	SWNM (NRVU)	SWNM (NRVU)
c	Typ urządzenia	JSW (UVU)	JSW (UVU)	JSW (UVU)	JSW (UVU)
d	Napęd	bezstopniowy	bezstopniowy	bezstopniowy	bezstopniowy
e	Typ odzysku ciepła	brak	brak	brak	brak
f	Sprawność temperaturowa [%]	nie dotyczy	nie dotyczy	nie dotyczy	nie dotyczy
g	Znamionowe natężenie przepływu w SWNM [m³/s]	0,15	0,22	0,36	0,54
h	Efektywny pobór mocy [kW]	0,15	0,25	0,27	0,54
i	JMWint [W/(m³/s)]	nie dotyczy	nie dotyczy	nie dotyczy	nie dotyczy
j	Prędkość czołowa [m/s]	1,8	1,8	1,8	2,2
k	$\Delta p_s$ , ext [Pa]	368,8	391,3	251	326
l	$\Delta p_s$ , int [Pa]	nie dotyczy	nie dotyczy	nie dotyczy	nie dotyczy
m	$\Delta p_s$ , add [Pa]	nie dotyczy	nie dotyczy	nie dotyczy	nie dotyczy
n	Sprawność statyczna wentylatora [%]	42,5	45,3	46,2	50,1
o	Stopień zewnętrznych przecieków powietrza [%]	3	3	3	3
p	Stopień wewnętrznych przecieków powietrza [%]	nie dotyczy	nie dotyczy	nie dotyczy	nie dotyczy
q	Efektywność energetyczna filtra	nie dotyczy	nie dotyczy	nie dotyczy	nie dotyczy
r	Ostrzeżenia o konieczności wymiany filtra	nie dotyczy	nie dotyczy	nie dotyczy	nie dotyczy
s	$L_{WA}$ [dB(A)]	58	61	55	61
	Strona internetowa	venture.pl solerpalau.com	venture.pl solerpalau.com	venture.pl solerpalau.com	venture.pl solerpalau.com

\* SWNM-"system wentylacyjny przeznaczony do budynków niemieszkalnych"-zgodnie z Rozporządzeniem Komisji (UE) nr 1253/2014